











# DC-Lasttrennschalter für Photovoltaik

nach IEC 60364-7-712



	Inhalt	Seite
	EIN-AUS-Schalter für Einbau 4-Lochbefestigung	294
	EIN-AUS-Schalter für Zentralbefestigung	295
	EIN-AUS-Schalter für Bodenmontage	296
	EIN-AUS-Schalter für Reiheneinbau	297
	Hauptschalter für Einbau 4-Lochbefestigung	298
	Hauptschalter für Zentralbefestigung	299
	Hauptschalter für Bodenmontage	300
	Hauptschalter für Reiheneinbau	301
	Hauptschalter, isolierstoffgekapselt	302
	Technische Daten Approbationen Maße	303 307 313

Nennwerte				DC-Lasttrennschalter				
Typ	Nennbetriebsstrom			Bauformen	Einbau IP66 <sup>1)</sup>	Zentral- befestigung Ø22,5mm IP66 <sup>1)</sup>	Verteilereinbau mit Türkupplung IP66 <sup>1)</sup>	Reiheneinbau IP40 <sup>1)</sup>
	$I_{th}$ offen A	DC21B 4 Kontakte in Serie A	bei $U_e$ V					
LS16	16	16	1000	.. E ..	.. Z(O) ..	.. VZV ..	.. SMA ..	
LS25	25	25	1000	.. E ..	.. Z(O) ..	.. VZV ..	.. SMA ..	
LS32	32	32	1000	.. E ..	.. Z(O) ..	.. VZV ..	.. SMA ..	
LS40	40	25	1000	.. E ..	-	.. VZV ..	.. SMA ..	
LS55	55	32	1000	.. E ..	-	.. VZV ..	.. SMA ..	

## Lasttrennschalter für Photovoltaik

Gemäß IEC 60364-7-712 „Errichten von Photovoltaik-Versorgungssystemen“ ist eine Einrichtung zum Trennen (= Lasttrennschalter) der Photovoltaik-Module vom Wechselrichter verbindlich vorgeschrieben.

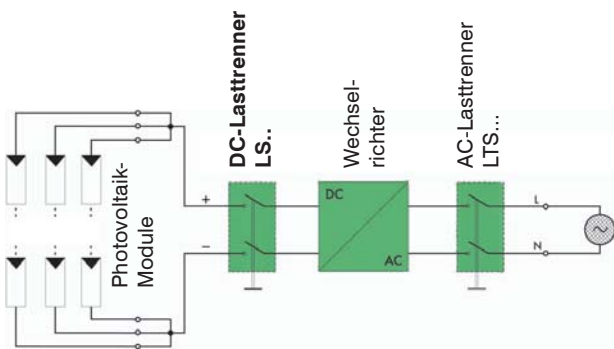

Lasttrennschalter „LS“ gewährleisten ein zuverlässiges Schalten von bis zu 58A bei 1000V in der Kategorie DC21B.

Die Kontakte sind gegen Oxydation (geringe Schalthäufigkeit) und somit gegen unzulässige Erwärmung geschützt.

Der Lasttrennschalter ist mit 2, 4, 6 oder 8 schaltbaren, einzelnen Kontakten ausgestattet. Durch Serien- und Parallelschaltung der Kontakte kann die Schaltleistung entsprechend erhöht werden.

Die hohe Schaltgeschwindigkeit der Kontakte ist unabhängig von der Betätigungsgeschwindigkeit des Handgriffes.

## Schaltprogramme

Typ	2-polig	2+2-polig 2 Pole in Serie + 2 Pole parallel	4-polig	4-polig mit Brücken Einspeisung oben Abgang unten	4-polig 2 Brücken oben Einspeisung und Abgang unten	4-polig 2 Brücken unten Einspeisung und Abgang oben
LS16	.. A2	.. A2+2	.. 2 x (A2)	.. A4B	.. A4O	.. A4U
LS25	.. A2	.. A2+2	.. 2 x (A2)	.. A4B	.. A4O	.. A4U
LS32	.. A2	.. A2+2	.. 2 x (A2)	.. A4B	.. A4O	.. A4U
LS40	.. A2	.. A2+2	.. 2 x (A2)	.. A4B	.. A4O	.. A4U
LS55	.. A2	.. A2+2	.. 2 x (A2)	.. A4B	.. A4O	.. A4U

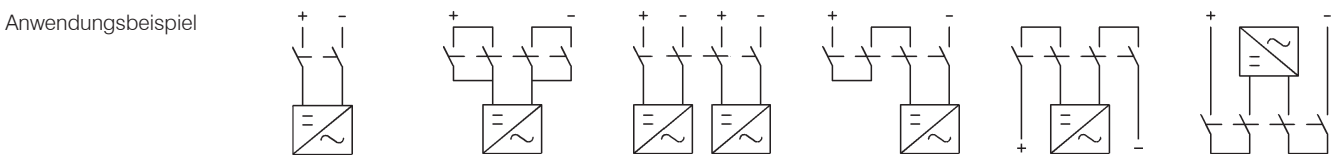
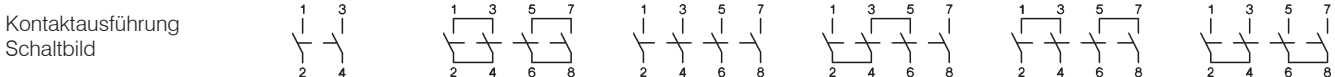



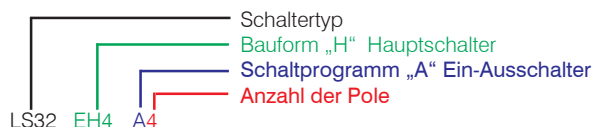

## Bestellanleitung





1) Schutzart von vorne im eingebauten Zustand

## DC-Hauptschalter

Einbau IP66 <sup>1)</sup>	Zentralbefestigung Ø22,5mm IP66 <sup>1)</sup>	Verteilereinbau mit Türkupplung IP66 <sup>1)</sup>	Reiheneinbau IP40 <sup>1)</sup>	Preßstoffgekapstelt IP66 <sup>1)</sup>
				
.. EH4. ..	.. Z(O)H1 ..	.. VZVH4 ..	.. SMAH1 ..	.. PFLH4 ..
.. EH4. ..	.. Z(O)H1 ..	.. VZVH4 ..	.. SMAH1 ..	.. PFLH4 ..
.. EH4. ..	.. Z(O)H1 ..	.. VZVH4 ..	.. SMAH1 ..	.. PFLH4 ..
.. EH4. ..	-	.. VZVH4 ..	.. SMAH1 ..	.. PFLH4 ..
.. EH4. ..	-	.. VZVH4 ..	.. SMAH1 ..	.. PFLH4 ..

### Technische Daten für DC, nach IEC 60947-3, VDE0660, weitere Daten siehe Seite 303

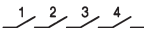
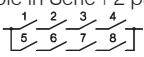
Typ		DC21A/B								DC22B			
		500V	600V	700V	800V	900V	1000V	1200V	1500V	500V	600V	800V	1000V
2 Pole in Serie 	<b>LS16 ..</b>	16A	16A	16A	16A	13A	9A	6A	3A	7A	5,5A	2A	1A
	<b>LS25..</b>	25A	25A	23A	20A	16A	11A	8A	4A	8A	6A	2,5A	1,5A
	<b>LS32 ..</b>	32A	32A	27A	23A	20A	13A	10A	5A	9A	6,5A	3A	2A
	<b>LS40 ..</b>	40A	40A	35A	30A	25A	20A	10A	6A	-	-	-	-
	<b>LS55..</b>	55A	55A	55A	45A	35A	36A	15A	8A	-	-	-	-
2 Pole in Serie+2 parallel 	<b>LS16 ..</b>	29A	29A	16A	16A	13A	9A	6A	3A	-	-	-	-
	<b>LS25..</b>	45A	45A	23A	20A	16A	11A	8A	4A	-	-	-	-
	<b>LS32 ..</b>	58A	50A	27A	23A	20A	13A	10A	5A	-	-	-	-
	<b>LS40 ..</b>	72A	64A	35A	30A	25A	20A	15A	10A	-	-	-	-
	<b>LS55..</b>	85A	80A	55A	45A	35A	25A	20A	15A	-	-	-	-
4 Pole in Serie 	<b>LS16 ..</b>	16A	16A	16A	16A	16A	16A	16A	16A	16A	16A	11,5A	8A
	<b>LS25..</b>	25A	25A	25A	25A	25A	25A	25A	20A	25A	25A	12A	9A
	<b>LS32 ..</b>	32A	32A	32A	32A	32A	32A	32A	23A	32A	27,5A	12,5A	10A
	<b>LS40 ..</b>	40A	40A	40A	40A	40A	40A	40A	30A	-	-	-	-
	<b>LS55..</b>	55A	55A	55A	55A	55A	55A	55A	40A	-	-	-	-
4 Pole in Serie+2 parallel 	<b>LS16 ..</b>	29A	29A	29A	29A	29A	29A	29A	16A	-	-	-	-
	<b>LS25..</b>	45A	45A	45A	45A	45A	45A	45A	20A	-	-	-	-
	<b>LS32 ..</b>	58A	58A	58A	58A	58A	58A	50A	23A	-	-	-	-

DC21 Schalten ohmscher Last einschließlich leichter Überlast bei Gleichspannung, Zeitkonstante L/R≤1ms  
 DC22 Schalten gemischter ohmscher Last einschließlich leichter Überlast bei Gleichspannung, Zeitkonstante L/R≤2,5ms (z.B.: Nebenschluß-Motore)

### Schaltprogramme

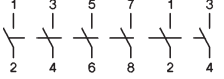
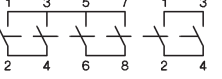
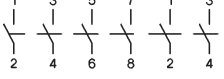
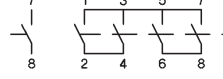
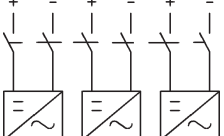
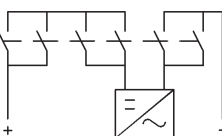
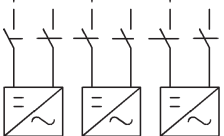
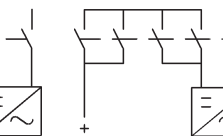
Typ	6-polig	3+2-polig 3 Pole in Serie +2 Pole parallel	8-polig	4+2-polig 4 Pole in serie +2 Pole parallel
<b>LS16</b>	...A6	.. A3+2	...A8	.. A4+2
<b>LS25</b>	...A6	.. A3+2	...A8	.. A4+2
<b>LS32</b>	...A6	.. A3+2	...A8	.. A4+2
<b>LS40</b>	-	-	-	-
<b>LS55</b>	-	-	-	-
Kontaktausführung Schaltbilder				
Anwendungsbeispiele				

### Isolierter Verbinder LSV-B1 für Serien- und Parallelschaltung von Kontakten

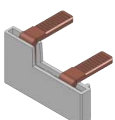

	Typ	VPE	Gewicht
<b>LS16, LS25, LS32</b>	<b>LSV-B1</b>	100	6,6 g/Stk.
<b>LS40, LS55</b>	<b>LSV-B2</b>	100	9,64 g/Stk.

# Ein-Aus-Schalter, Fronteinbau m. Vierlochbefestigung, Schild 64□, Schutzart IP66, Typ 3R



DC21B 600V DC	1000V DC	Anzahl Pole in Serie	Anzahl Strings	Typ	VPE Stk.	Gewicht kg/Stk.
16A	9A	2	1	<b>LS16 E A2</b>	1	0,20
25A	11A	2	1	<b>LS25 E A2</b>	1	0,20
32A	13A	2	1	<b>LS32 E A2</b>	1	0,20
40A	20A	2	1	<b>LS40 E A2</b>	1	0,41
55A	25A	2	1	<b>LS55 E A2</b>	1	0,41

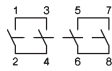

29A	9A	2	1	<b>LS16 E A2+2</b>	1	0,25
45A	11A	2	1	<b>LS25 E A2+2</b>	1	0,25
50A	13A	2	1	<b>LS32 E A2+2</b>	1	0,25
64A	20A	2	1	<b>LS40 E A2+2</b>	1	0,54
80A	25A	2	1	<b>LS55 E A2+2</b>	1	0,54

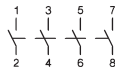

16A	9A	2	2	<b>LS16 E A4</b>	1	0,23
25A	11A	2	2	<b>LS25 E A4</b>	1	0,23
32A	13A	2	2	<b>LS32 E A4</b>	1	0,23
40A	20A	2	2	<b>LS40 E A4</b>	1	0,49
55A	25A	2	2	<b>LS55 E A4</b>	1	0,49

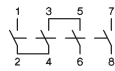

16A	16A	4	1	<b>LS16 E A4B</b>	1	0,24
25A	25A	4	1	<b>LS25 E A4B</b>	1	0,24
32A	32A	4	1	<b>LS32 E A4B</b>	1	0,24
40A	40A	4	1	<b>LS40 E A4B</b>	1	0,52
55A	55A	4	1	<b>LS55 E A4B</b>	1	0,52

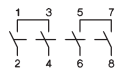

16A	16A	4	1	<b>LS16 E A4O</b>	1	0,24
25A	25A	4	1	<b>LS25 E A4O</b>	1	0,24
32A	32A	4	1	<b>LS32 E A4O</b>	1	0,24
40A	40A	4	1	<b>LS40 E A4O</b>	1	0,52
55A	55A	4	1	<b>LS55 E A4O</b>	1	0,52

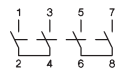

16A	16A	4	1	<b>LS16 E A4U</b>	1	0,24
25A	25A	4	1	<b>LS25 E A4U</b>	1	0,24
32A	32A	4	1	<b>LS32 E A4U</b>	1	0,24
40A	40A	4	1	<b>LS40 E A4U</b>	1	0,52
55A	55A	4	1	<b>LS55 E A4U</b>	1	0,52

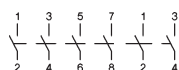

16A	9A	2	3	<b>LS16 E A6</b>	1	0,36
25A	11A	2	3	<b>LS25 E A6</b>	1	0,36
32A	13A	2	3	<b>LS32 E A6</b>	1	0,36

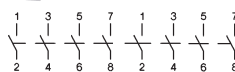

16A	9A	2	4	<b>LS16 E A8</b>	1	0,41
25A	11A	2	4	<b>LS25 E A8</b>	1	0,41
32A	13A	2	4	<b>LS32 E A8</b>	1	0,41

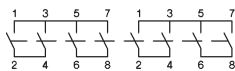

29A	29A	4	1	<b>LS16 E A4+2</b>	1	0,46
45A	45A	4	1	<b>LS25 E A4+2</b>	1	0,46
58A	58A	4	1	<b>LS32 E A4+2</b>	1	0,46

## Verlängerte Schalterwelle für Schalter für Fronteinbau

Typenzusatz **+VW"x"** x = Paneelstärke

# Ein-Aus-Schalter, Zentralbefestigung Ø22mm, Schild 48□, Schutzart IP66, c Typ 3R



DC21B 600V DC	1000V DC	Anzahl Pole in Serie	Anzahl Strings	Typ	VPE Stk.	Gewicht kg/Stk.
16A	9A	2	1	<b>LS16 Z A2</b>	1	0,21
25A	11A	2	1	<b>LS25 Z A2</b>	1	0,21
32A	13A	2	1	<b>LS32 Z A2</b>	1	0,21

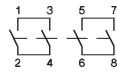

29A	9A	2	1	<b>LS16 Z A2+2</b>	1	0,26
45A	11A	2	1	<b>LS25 Z A2+2</b>	1	0,26
50A	13A	2	1	<b>LS32 Z A2+2</b>	1	0,26

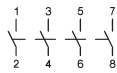

16A	9A	2	2	<b>LS16 Z A4</b>	1	0,23
25A	11A	2	2	<b>LS25 Z A4</b>	1	0,23
32A	13A	2	2	<b>LS32 Z A4</b>	1	0,23

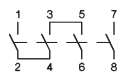

16A	16A	4	1	<b>LS16 Z A4B</b>	1	0,25
25A	25A	4	1	<b>LS25 Z A4B</b>	1	0,25
32A	32A	4	1	<b>LS32 Z A4B</b>	1	0,25

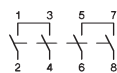

16A	16A	4	1	<b>LS16 Z A4O</b>	1	0,25
25A	25A	4	1	<b>LS25 Z A4O</b>	1	0,25
32A	32A	4	1	<b>LS32 Z A4O</b>	1	0,25

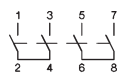

16A	16A	4	1	<b>LS16 Z A4U</b>	1	0,25
25A	25A	4	1	<b>LS25 Z A4U</b>	1	0,25
32A	32A	4	1	<b>LS32 Z A4U</b>	1	0,25

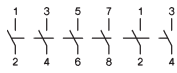

16A	9A	2	3	<b>LS16 Z A6</b>	1	0,38
25A	11A	2	3	<b>LS25 Z A6</b>	1	0,38
32A	13A	2	3	<b>LS32 Z A6</b>	1	0,38

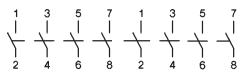

16A	9A	2	4	<b>LS16 Z A8</b>	1	0,43
25A	11A	2	4	<b>LS25 Z A8</b>	1	0,43
32A	13A	2	4	<b>LS32 Z A8</b>	1	0,43

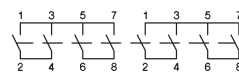

29A	29A	4	1	<b>LS16 Z A4+2</b>	1	0,48
45A	45A	4	1	<b>LS25 Z A4+2</b>	1	0,48
58A	58A	4	1	<b>LS32 Z A4+2</b>	1	0,48

# Ein-Aus-Schalter, Zentralbefestigung Ø22mm, ohne Schild, Schutzart IP66, c Typ 3R

bei Type „Z“ durch „ZO“ ersetzen **LS.. ZO A.**

Ein-Aus-Schalter, Bodenmontage, Türkupplung für Zentralbefestigung, Schild 64□, IP66,   Typ 3R



DC21B 600V DC	1000V DC	Anzahl Pole in Serie	Anzahl Strings	Typ	VPE Stk.	Gewicht kg/Stk.
16A	9A	2	1	<b>LS16 VZV A2</b>	1	0,22
25A	11A	2	1	<b>LS25 VZV A2</b>	1	0,22
32A	13A	2	1	<b>LS32 VZV A2</b>	1	0,22
40A	20A	2	1	<b>LS40 VZV A2</b>	1	0,51
55A	25A	2	1	<b>LS55 VZV A2</b>	1	0,51

Einbautiefe einstellbar

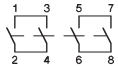

29A	9A	2	1	<b>LS16 VZV A2+2</b>	1	0,27
45A	11A	2	1	<b>LS25 VZV A2+2</b>	1	0,27
50A	13A	2	1	<b>LS32 VZV A2+2</b>	1	0,27
64A	20A	2	1	<b>LS40 VZV A2+2</b>	1	0,55
80A	25A	2	1	<b>LS55 VZV A2+2</b>	1	0,55

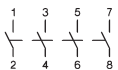

16A	9A	2	2	<b>LS16 VZV A4</b>	1	0,25
25A	11A	2	2	<b>LS25 VZV A4</b>	1	0,25
32A	13A	2	2	<b>LS32 VZV A4</b>	1	0,25
40A	20A	2	2	<b>LS40 VZV A4</b>	1	0,56
55A	25A	2	2	<b>LS55 VZV A4</b>	1	0,56

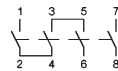

16A	16A	4	1	<b>LS16 VZV A4B</b>	1	0,26
25A	25A	4	1	<b>LS25 VZV A4B</b>	1	0,26
32A	32A	4	1	<b>LS32 VZV A4B</b>	1	0,26
40A	40A	4	1	<b>LS40 VZV A4B</b>	1	0,58
55A	55A	4	1	<b>LS55 VZV A4B</b>	1	0,58

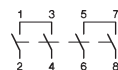

16A	16A	4	1	<b>LS16 VZV A4O</b>	1	0,26
25A	25A	4	1	<b>LS25 VZV A4O</b>	1	0,26
32A	32A	4	1	<b>LS32 VZV A4O</b>	1	0,26
40A	40A	4	1	<b>LS40 VZV A4O</b>	1	0,58
55A	55A	4	1	<b>LS55 VZV A4O</b>	1	0,58

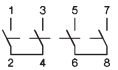

16A	16A	4	1	<b>LS16 VZV A4U</b>	1	0,26
25A	25A	4	1	<b>LS25 VZV A4U</b>	1	0,26
32A	32A	4	1	<b>LS32 VZV A4U</b>	1	0,26
40A	40A	4	1	<b>LS40 VZV A4U</b>	1	0,58
55A	55A	4	1	<b>LS55 VZV A4U</b>	1	0,58

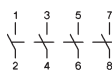

16A	9A	2	3	<b>LS16 VZV A6</b>	1	0,38
25A	11A	2	3	<b>LS25 VZV A6</b>	1	0,38
32A	13A	2	3	<b>LS32 VZV A6</b>	1	0,38

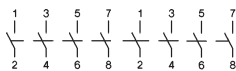

16A	9A	2	4	<b>LS16 VZV A8</b>	1	0,43
25A	11A	2	4	<b>LS25 VZV A8</b>	1	0,43
32A	13A	2	4	<b>LS32 VZV A8</b>	1	0,43

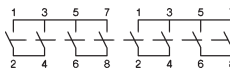

29A	29A	4	1	<b>LS16 VZV A4+2</b>	1	0,48
45A	45A	4	1	<b>LS25 VZV A4+2</b>	1	0,48
58A	58A	4	1	<b>LS32 VZV A4+2</b>	1	0,48

# Ein-Aus-Schalter, Reiheneinbau, Schutzart IP40, Typ 1



DC21B 600V DC	1000V DC	Anzahl Pole in Serie	Anzahl Strings	Typ	VPE Stk.	Gewicht kg/Stk.
16A	9A	2	1	<b>LS16 SMA A2</b>	1	0,19
25A	11A	2	1	<b>LS25 SMA A2</b>	1	0,19
32A	13A	2	1	<b>LS32 SMA A2</b>	1	0,19
40A	20A	2	1	<b>LS40 SMA A2</b>	1	0,41
55A	25A	2	1	<b>LS55 SMA A2</b>	1	0,41

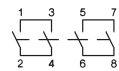

29A	9A	2	1	<b>LS16 SMA A2+2</b>	1	0,24
45A	11A	2	1	<b>LS25 SMA A2+2</b>	1	0,24
50A	13A	2	1	<b>LS32 SMA A2+2</b>	1	0,24
64A	20A	2	1	<b>LS40 SMA A2+2</b>	1	0,52
80A	25A	2	1	<b>LS55 SMA A2+2</b>	1	0,52

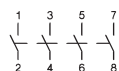

16A	9A	2	2	<b>LS16 SMA A4</b>	1	0,22
25A	11A	2	2	<b>LS25 SMA A4</b>	1	0,22
32A	13A	2	2	<b>LS32 SMA A4</b>	1	0,22
40A	20A	2	2	<b>LS40 SMA A4</b>	1	0,45
55A	25A	2	2	<b>LS55 SMA A4</b>	1	0,45

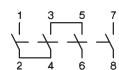

16A	16A	4	1	<b>LS16 SMA A4B</b>	1	0,23
25A	25A	4	1	<b>LS25 SMA A4B</b>	1	0,23
32A	32A	4	1	<b>LS32 SMA A4B</b>	1	0,23
40A	40A	4	1	<b>LS40 SMA A4B</b>	1	0,49
55A	55A	4	1	<b>LS55 SMA A4B</b>	1	0,49

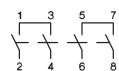

16A	16A	4	1	<b>LS16 SMA A4O</b>	1	0,23
25A	25A	4	1	<b>LS25 SMA A4O</b>	1	0,23
32A	32A	4	1	<b>LS32 SMA A4O</b>	1	0,23
40A	40A	4	1	<b>LS40 SMA A4O</b>	1	0,49
55A	55A	4	1	<b>LS55 SMA A4O</b>	1	0,49

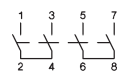

16A	16A	4	1	<b>LS16 SMA A4U</b>	1	0,23
25A	25A	4	1	<b>LS25 SMA A4U</b>	1	0,23
32A	32A	4	1	<b>LS32 SMA A4U</b>	1	0,23
40A	40A	4	1	<b>LS40 SMA A4U</b>	1	0,49
55A	55A	4	1	<b>LS55 SMA A4U</b>	1	0,49

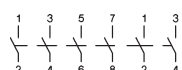

16A	9A	2	3	<b>LS16 SMA A6</b>	1	0,35
25A	11A	2	3	<b>LS25 SMA A6</b>	1	0,35
32A	13A	2	3	<b>LS32 SMA A6</b>	1	0,35

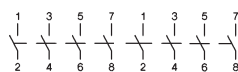

16A	9A	2	4	<b>LS16 SMA A8</b>	1	0,40
25A	11A	2	4	<b>LS25 SMA A8</b>	1	0,40
32A	13A	2	4	<b>LS32 SMA A8</b>	1	0,40

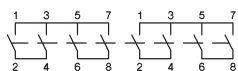

29A	29A	4	1	<b>LS16 SMA A4+2</b>	1	0,43
45A	45A	4	1	<b>LS25 SMA A4+2</b>	1	0,43
58A	58A	4	1	<b>LS32 SMA A4+2</b>	1	0,43

Schütze, Motorstarter

Leistungsschalter

Motorschutzschalter

Schalter

AC-Hauptschalter

DC-Lasttrennschalter

Befehls- und Meldegeräte

Vertretungen, Bezugsquellen

# Hauptschalter, Fronteinbau m. Vierlochbefestigung, Schild 64□, Schutzart IP66, Typ 3R



DC21B 600V DC	1000V DC	Anzahl Pole in Serie	Anzahl Strings	Typ	VPE Stk.	Gewicht kg/Stk.
16A	9A	2	1	<b>LS16 EH4 A2</b>	1	0,21
25A	11A	2	1	<b>LS25 EH4 A2</b>	1	0,21
32A	13A	2	1	<b>LS32 EH4 A2</b>	1	0,21
40A	20A	2	1	<b>LS40 EH4 A2</b>	1	0,43
55A	25A	2	1	<b>LS55 EH4 A2</b>	1	0,43

Sperrvorrichtung SV4

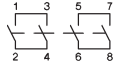

29A	9A	2	1	<b>LS16 EH4 A2+2</b>	1	0,26
45A	11A	2	1	<b>LS25 EH4 A2+2</b>	1	0,26
50A	13A	2	1	<b>LS32 EH4 A2+2</b>	1	0,26
64A	20A	2	1	<b>LS40 EH4 A2+2</b>	1	0,57
80A	25A	2	1	<b>LS55 EH4 A2+2</b>	1	0,57

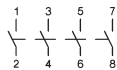

16A	9A	2	2	<b>LS16 EH4 A4</b>	1	0,24
25A	11A	2	2	<b>LS25 EH4 A4</b>	1	0,24
32A	13A	2	2	<b>LS32 EH4 A4</b>	1	0,24
40A	20A	2	2	<b>LS40 EH4 A4</b>	1	0,50
55A	25A	2	2	<b>LS55 EH4 A4</b>	1	0,50

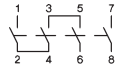

16A	16A	4	1	<b>LS16 EH4 A4B</b>	1	0,25
25A	25A	4	1	<b>LS25 EH4 A4B</b>	1	0,25
32A	32A	4	1	<b>LS32 EH4 A4B</b>	1	0,25
40A	40A	4	1	<b>LS40 EH4 A4B</b>	1	0,53
55A	55A	4	1	<b>LS55 EH4 A4B</b>	1	0,53

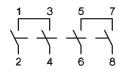

16A	16A	4	1	<b>LS16 EH4 A4O</b>	1	0,25
25A	25A	4	1	<b>LS25 EH4 A4O</b>	1	0,25
32A	32A	4	1	<b>LS32 EH4 A4O</b>	1	0,25
40A	40A	4	1	<b>LS40 EH4 A4O</b>	1	0,53
55A	55A	4	1	<b>LS55 EH4 A4O</b>	1	0,53

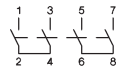

16A	16A	4	1	<b>LS16 EH4 A4U</b>	1	0,25
25A	25A	4	1	<b>LS25 EH4 A4U</b>	1	0,25
32A	32A	4	1	<b>LS32 EH4 A4U</b>	1	0,25
40A	40A	4	1	<b>LS40 EH4 A4U</b>	1	0,53
55A	55A	4	1	<b>LS55 EH4 A4U</b>	1	0,53

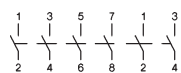

16A	9A	2	3	<b>LS16 EH4 A6</b>	1	0,37
25A	11A	2	3	<b>LS25 EH4 A6</b>	1	0,37
32A	13A	2	3	<b>LS32 EH4 A6</b>	1	0,37

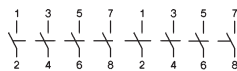

16A	9A	2	4	<b>LS16 EH4 A8</b>	1	0,42
25A	11A	2	4	<b>LS25 EH4 A8</b>	1	0,42
32A	13A	2	4	<b>LS32 EH4 A8</b>	1	0,42

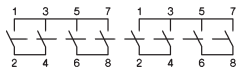







29A	29A	4	1	<b>LS16 EH4 A4+2</b>	1	0,47
45A	45A	4	1	<b>LS25 EH4 A4+2</b>	1	0,47
58A	58A	4	1	<b>LS32 EH4 A4+2</b>	1	0,47

## Verlängerte Schalterwelle für Schalter für Fronteinbau

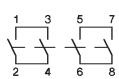
Typenzusatz **+VW"x"** x = Paneelstärke

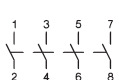
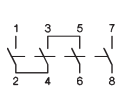
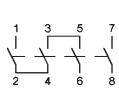
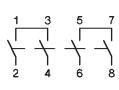
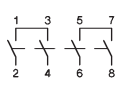
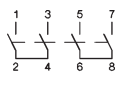
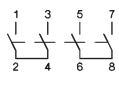
# Hauptschalter, Zentralbefestigung Ø22mm, Schild 48□, Schutzart IP66, Typ 3R

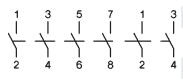
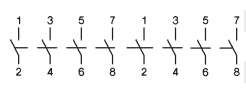
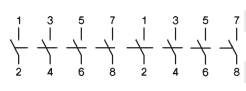
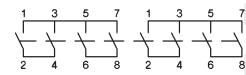
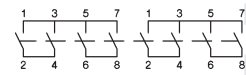
		DC21B 600V DC	1000V DC	Anzahl Pole in Serie	Anzahl Strings	Typ	VPE Stk.	Gewicht kg/Stk.
		16A	9A	2	1	<b>LS16 ZH1 A2</b>	1	0,21
		25A	11A	2	1	<b>LS25 ZH1 A2</b>	1	0,21
		32A	13A	2	1	<b>LS32 ZH1 A2</b>	1	0,21
Sperrvorrichtung SV1		29A	9A	2	1	<b>LS16 ZH1 A2+2</b>	1	0,27
		45A	11A	2	1	<b>LS25 ZH1 A2+2</b>	1	0,27
		50A	13A	2	1	<b>LS32 ZH1 A2+2</b>	1	0,27
		16A	9A	2	2	<b>LS16 ZH1 A4</b>	1	0,24
		25A	11A	2	2	<b>LS25 ZH1 A4</b>	1	0,24
		32A	13A	2	2	<b>LS32 ZH1 A4</b>	1	0,24
		16A	16A	4	1	<b>LS16 ZH1 A4B</b>	1	0,25
		25A	25A	4	1	<b>LS25 ZH1 A4B</b>	1	0,25
		32A	32A	4	1	<b>LS32 ZH1 A4B</b>	1	0,25
		16A	16A	4	1	<b>LS16 ZH1 A4O</b>	1	0,25
		25A	25A	4	1	<b>LS25 ZH1 A4O</b>	1	0,25
		32A	32A	4	1	<b>LS32 ZH1 A4O</b>	1	0,25
		16A	16A	4	1	<b>LS16 ZH1 A4U</b>	1	0,25
		25A	25A	4	1	<b>LS25 ZH1 A4U</b>	1	0,25
		32A	32A	4	1	<b>LS32 ZH1 A4U</b>	1	0,25
		16A	9A	2	3	<b>LS16 ZH1 A6</b>	1	0,39
		25A	11A	2	3	<b>LS25 ZH1 A6</b>	1	0,39
		32A	13A	2	3	<b>LS32 ZH1 A6</b>	1	0,39
		16A	9A	2	4	<b>LS16 ZH1 A8</b>	1	0,44
		25A	11A	2	4	<b>LS25 ZH1 A8</b>	1	0,44
		32A	13A	2	4	<b>LS32 ZH1 A8</b>	1	0,44
		29A	29A	4	1	<b>LS16 ZH1 A4+2</b>	1	0,49
		45A	45A	4	1	<b>LS25 ZH1 A4+2</b>	1	0,49
		58A	58A	4	1	<b>LS32 ZH1 A4+2</b>	1	0,49

# Hauptschalter, Zentralbefestigung Ø22mm, ohne Schild, Schutzart IP66, Typ 3R

bei Type „ZH1“ durch „ZOH1“ ersetzen **LS.. ZOH1 A.**

Hauptschalter, Bodenmontage, Türkupplung für Zentralbefestigung, Schild 64<sup>□</sup>, Schutzart IP66,   Typ 3R



DC21B 600V DC	1000V DC	Anzahl Pole in Serie	Anzahl Strings	Typ	VPE Stk.	Gewicht kg/Stk.
16A	9A	2	1	<b>LS16 VZVH4 A2</b>	1	0,23
25A	11A	2	1	<b>LS25 VZVH4 A2</b>	1	0,23
32A	13A	2	1	<b>LS32 VZVH4 A2</b>	1	0,23
40A	20A	2	1	<b>LS40 VZVH4 A2</b>	1	0,51
55A	25A	2	1	<b>LS55 VZVH4 A2</b>	1	0,51

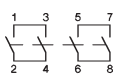

29A	9A	2	1	<b>LS16 VZVH4 A2+2</b>	1	0,28
45A	11A	2	1	<b>LS25 VZVH4 A2+2</b>	1	0,28
50A	13A	2	1	<b>LS32 VZVH4 A2+2</b>	1	0,28
64A	20A	2	1	<b>LS40 VZVH4 A2+2</b>	1	0,65
80A	25A	2	1	<b>LS55 VZVH4 A2+2</b>	1	0,65

Einbautiefe einstellbar

Sperrvorrichtung SV4

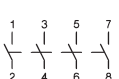

16A	9A	2	2	<b>LS16 VZVH4 A4</b>	1	0,26
25A	11A	2	2	<b>LS25 VZVH4 A4</b>	1	0,26
32A	13A	2	2	<b>LS32 VZVH4 A4</b>	1	0,26
40A	20A	2	2	<b>LS40 VZVH4 A4</b>	1	0,58
55A	25A	2	2	<b>LS55 VZVH4 A4</b>	1	0,58

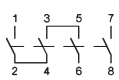

16A	16A	4	1	<b>LS16 VZVH4 A4B</b>	1	0,27
25A	25A	4	1	<b>LS25 VZVH4 A4B</b>	1	0,27
32A	32A	4	1	<b>LS32 VZVH4 A4B</b>	1	0,27
40A	40A	4	1	<b>LS40 VZVH4 A4B</b>	1	0,62
55A	55A	4	1	<b>LS55 VZVH4 A4B</b>	1	0,62

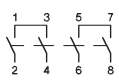

16A	16A	4	1	<b>LS16 VZVH4 A4O</b>	1	0,27
25A	25A	4	1	<b>LS25 VZVH4 A4O</b>	1	0,27
32A	32A	4	1	<b>LS32 VZVH4 A4O</b>	1	0,27
40A	40A	4	1	<b>LS40 VZVH4 A4O</b>	1	0,62
55A	55A	4	1	<b>LS55 VZVH4 A4O</b>	1	0,62

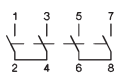

16A	16A	4	1	<b>LS16 VZVH4 A4U</b>	1	0,27
25A	25A	4	1	<b>LS25 VZVH4 A4U</b>	1	0,27
32A	32A	4	1	<b>LS32 VZVH4 A4U</b>	1	0,27
40A	40A	4	1	<b>LS40 VZVH4 A4U</b>	1	0,62
55A	55A	4	1	<b>LS55 VZVH4 A4U</b>	1	0,62

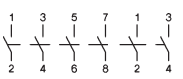

16A	9A	2	3	<b>LS16 VZVH4 A6</b>	1	0,39
25A	11A	2	3	<b>LS25 VZVH4 A6</b>	1	0,39
32A	13A	2	3	<b>LS32 VZVH4 A6</b>	1	0,39

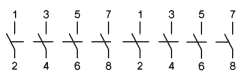

16A	9A	2	4	<b>LS16 VZVH4 A8</b>	1	0,44
25A	11A	2	4	<b>LS25 VZVH4 A8</b>	1	0,44
32A	13A	2	4	<b>LS32 VZVH4 A8</b>	1	0,44

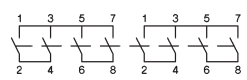

29A	29A	4	1	<b>LS16 VZVH4 A4+2</b>	1	0,49
45A	45A	4	1	<b>LS25 VZVH4 A4+2</b>	1	0,49
58A	58A	4	1	<b>LS32 VZVH4 A4+2</b>	1	0,49

# Hauptschalter, Reiheneinbau, versperbar, Schutzart IP40, c Typ 1



DC21B 600V DC	1000V DC	Anzahl Pole in Serie	Anzahl Strings	Typ	VPE Stk.	Gewicht kg/Stk.
16A	9A	2	1	<b>LS16 SMAH1 A2</b>	1	0,19
25A	11A	2	1	<b>LS25 SMAH1 A2</b>	1	0,19
32A	13A	2	1	<b>LS32 SMAH1 A2</b>	1	0,19
40A	20A	2	1	<b>LS40 SMAH1 A2</b>	1	0,40
55A	25A	2	1	<b>LS55 SMAH1 A2</b>	1	0,40

Sperrvorrichtung SV1

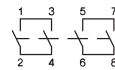

29A	9A	2	1	<b>LS16 SMAH1 A2+2 <sup>1)</sup></b>	1	0,25
45A	11A	2	1	<b>LS25 SMAH1 A2+2 <sup>1)</sup></b>	1	0,25
50A	13A	2	1	<b>LS32 SMAH1 A2+2 <sup>1)</sup></b>	1	0,25
64A	20A	2	1	<b>LS40 SMAH1 A2+2</b>	1	0,54
80A	25A	2	1	<b>LS55 SMAH1 A2+2</b>	1	0,54

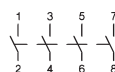

16A	9A	2	2	<b>LS16 SMAH1 A4 <sup>1)</sup></b>	1	0,22
25A	11A	2	2	<b>LS25 SMAH1 A4 <sup>1)</sup></b>	1	0,22
32A	13A	2	2	<b>LS32 SMAH1 A4 <sup>1)</sup></b>	1	0,22
40A	20A	2	2	<b>LS40 SMAH1 A4</b>	1	0,47
55A	25A	2	2	<b>LS55 SMAH1 A4</b>	1	0,47

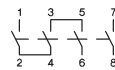

16A	16A	4	1	<b>LS16 SMAH1 A4B <sup>1)</sup></b>	1	0,23
25A	25A	4	1	<b>LS25 SMAH1 A4B <sup>1)</sup></b>	1	0,23
32A	32A	4	1	<b>LS32 SMAH1 A4B <sup>1)</sup></b>	1	0,23
40A	40A	4	1	<b>LS40 SMAH1 A4B</b>	1	0,50
55A	55A	4	1	<b>LS55 SMAH1 A4B</b>	1	0,50

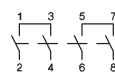

16A	16A	4	1	<b>LS16 SMAH1 A4O <sup>1)</sup></b>	1	0,23
25A	25A	4	1	<b>LS25 SMAH1 A4O <sup>1)</sup></b>	1	0,23
32A	32A	4	1	<b>LS32 SMAH1 A4O <sup>1)</sup></b>	1	0,23
40A	40A	4	1	<b>LS40 SMAH1 A4B</b>	1	0,50
55A	55A	4	1	<b>LS55 SMAH1 A4B</b>	1	0,50

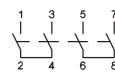

16A	16A	4	1	<b>LS16 SMAH1 A4U <sup>1)</sup></b>	1	0,23
25A	25A	4	1	<b>LS25 SMAH1 A4U <sup>1)</sup></b>	1	0,23
32A	32A	4	1	<b>LS32 SMAH1 A4U <sup>1)</sup></b>	1	0,23
40A	40A	4	1	<b>LS40 SMAH1 A4B</b>	1	0,50
55A	55A	4	1	<b>LS55 SMAH1 A4B</b>	1	0,50

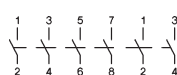

16A	9A	2	3	<b>LS16 SMAH1 A6</b>	1	0,36
25A	11A	2	3	<b>LS25 SMAH1 A6</b>	1	0,36
32A	13A	2	3	<b>LS32 SMAH1 A6</b>	1	0,36

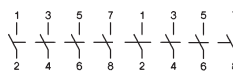

16A	9A	2	4	<b>LS16 SMAH1 A8</b>	1	0,41
25A	11A	2	4	<b>LS25 SMAH1 A8</b>	1	0,41
32A	13A	2	4	<b>LS32 SMAH1 A8</b>	1	0,41

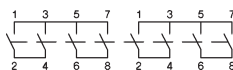

29A	29A	4	1	<b>LS16 SMAH1 A4+2</b>	1	0,46
45A	45A	4	1	<b>LS25 SMAH1 A4+2</b>	1	0,46
58A	58A	4	1	<b>LS32 SMAH1 A4+2</b>	1	0,46









<sup>1)</sup> Hauptschalter, Reiheneinbau mit niedrigem Griff, versperbar, Schutzart IP40,  c  Typ 1

Typ mit Typenzusatz „+SV1N“ z.B.: **LS.. SMAH1 A2+2 +SV1N**

# Hauptschalter, isolierstoffgepackelt, Schild 64<sup>□</sup>, Schutzart IP66, Typ 3R <sup>1)</sup>



Sperrvorrichtung SV4

	DC21B 600V DC	1000V DC	Anzahl Pole in Serie	Anzahl Strings	Typ	VPE Stk.	Gewicht kg/Stk.
	16A	9A	2	1	<b>LS16 PFLH4 A2</b>	1	0,43
	25A	11A	2	1	<b>LS25 PFLH4 A2</b>	1	0,43
	32A	13A	2	1	<b>LS32 PFLH4 A2</b>	1	0,43
	40A	20A	2	1	<b>LS40 PFH4 A2 <sup>2)</sup></b>	1	1,59
	55A	25A	2	1	<b>LS55 PFH4 A2 <sup>2)</sup></b>	1	1,59
	29A	9A	2	1	<b>LS16 PFLH4 A2+2</b>	1	0,49
	45A	11A	2	1	<b>LS25 PFLH4 A2+2</b>	1	0,49
	50A	13A	2	1	<b>LS32 PFLH4 A2+2</b>	1	0,49
	64A	20A	2	1	<b>LS40 PFH4 A2+2 <sup>2)</sup></b>	1	1,74
	80A	25A	2	1	<b>LS55 PFH4 A2+2 <sup>2)</sup></b>	1	1,74
	16A	9A	2	2	<b>LS16 PFLH4 A4</b>	1	0,46
	25A	11A	2	2	<b>LS25 PFLH4 A4</b>	1	0,46
	32A	13A	2	2	<b>LS32 PFLH4 A4</b>	1	0,46
	40A	20A	2	2	<b>LS40 PFH4 A4 <sup>2)</sup></b>	1	1,67
	55A	25A	2	2	<b>LS55 PFH4 A4 <sup>2)</sup></b>	1	1,67
	16A	16A	4	1	<b>LS16 PFLH4 A4B</b>	1	0,47
	25A	25A	4	1	<b>LS25 PFLH4 A4B</b>	1	0,47
	32A	32A	4	1	<b>LS32 PFLH4 A4B</b>	1	0,47
	40A	40A	4	1	<b>LS40 PFH4 A4B <sup>2)</sup></b>	1	1,70
	55A	55A	4	1	<b>LS55 PFH4 A4B <sup>2)</sup></b>	1	1,70
	16A	16A	4	1	<b>LS16 PFLH4 A4O</b>	1	0,47
	25A	25A	4	1	<b>LS25 PFLH4 A4O</b>	1	0,47
	32A	32A	4	1	<b>LS32 PFLH4 A4O</b>	1	0,47
	40A	40A	4	1	<b>LS40 PFH4 A4O <sup>2)</sup></b>	1	1,70
	55A	55A	4	1	<b>LS55 PFH4 A4O <sup>2)</sup></b>	1	1,70
	16A	16A	4	1	<b>LS16 PFLH4 A4U</b>	1	0,47
	25A	25A	4	1	<b>LS25 PFLH4 A4U</b>	1	0,47
	32A	32A	4	1	<b>LS32 PFLH4 A4U</b>	1	0,47
	40A	40A	4	1	<b>LS40 PFH4 A4U <sup>2)</sup></b>	1	1,70
	55A	55A	4	1	<b>LS55 PFH4 A4U <sup>2)</sup></b>	1	1,70
	16A	9A	2	3	<b>LS16 PFH4 A6</b>	1	1,53
	25A	11A	2	3	<b>LS25 PFH4 A6</b>	1	1,53
	32A	13A	2	3	<b>LS32 PFH4 A6</b>	1	1,53
	16A	9A	2	4	<b>LS16 PFH4 A8</b>	1	1,58
	25A	11A	2	4	<b>LS25 PFH4 A8</b>	1	1,58
	32A	13A	2	4	<b>LS32 PFH4 A8</b>	1	1,58
	29A	29A	4	1	<b>LS16 PFH4 A4+2</b>	1	1,63
	45A	45A	4	1	<b>LS25 PFH4 A4+2</b>	1	1,63
	58A	58A	4	1	<b>LS32 PFH4 A4+2</b>	1	1,63

Gehäuse mit Gewinde

Typenzusatz: +M25

1) Typ 3R nicht anwendbar für die Serien LS40 und LS55

2) Typ 1

# Technische Daten

Stromart	Gebrauchskategorie		Typische Anwendungsfälle	Prüfungsbedingungen für Elektrische Lebensdauer (Normale Beanspruchung)						Prüfungsbedingungen für Ein- und Ausschaltvermögen (Beanspruchung im Störungfall)					
				Einschalten			Ausschalten			Einschalten			Ausschalten		
				I/le	U/le	L/R	Ic/le	Ur/le	L/R	I/le	U/le	L/R	Ic/le	Ur/le	L/R
Gleichstrom	<b>DC21A</b> häufige Betätigung	<b>DC21B</b> gelegentl. Betätigung	Schalten von ohmscher Last einschließlich geringer Überlast.	1	1	1ms	1	1	1ms	1,5	1,05	1ms	1,5	1,05	1ms
	<b>DC22A</b> häufige Betätigung	<b>DC22B</b> gelegentl. Betätigung	Schalten von gemischter ohmscher und induktiver Last einschließl. geringer Überlast.	1	1	2ms	1	1	2ms	4	1,05	2,5ms	4	1,05	2,5ms
	<b>DC-PV1</b>		Schalten eines einzelnen PV String(s) ohne Rück- und Überströme.	1	1	1ms	1	1	1ms	1,5	1,05	1ms	1,5	1,05	1ms
	<b>DC-PV2</b>		Schalten von mehreren PV Strings mit Rück- und Überströmen.	1	1	1ms	1	1	1ms	4	1,05	1ms	4	1,05	1ms

## Daten nach IEC 60947-3, VDE 0660, GB14048.3 (CCC China)



Hauptkontakte		Typ	LS16	LS25	LS32	LS40	LS55	
Thermischer Bemessungsstrom $I_{th}$		A	16	25	32	40	55	
Bemessungsisolationsspannung $U_i$ <sup>1)</sup>		V	1000	1000	1000	1500	1500	
Bemessungsisolationsspannung $U_i$ <sup>2)</sup>		V	1500	1500	1500	-	-	
Kontaktabstand (pro Pol)		mm	8	8	8			
<b>DC21A und DC21B</b>	1 Pol	300V A	16	23	27	40	55	
		400V A	12	14	16	30	40	
		500V A	9	11	13	19	25	
		600V A	6	8	10	15	20	
		700V A	4,5	6	7,5	10	15	
	<b>DC21B</b>	800V A	3	4	5	8	10	
		900V A	2,5	3	4	6	8	
		1000V A	1,5	2	2,5	4	6	
		2 Pole in Serie A2	500V A	16	25	32	40	55
			600V A	16	25	32	40	55
700V A	16		23	27	35	55		
800V A	16		20	23	30	45		
850V A	-		-	25	-	-		
<b>DC21B</b>	900V A	13	16	20	25	35		
	1000V A	9	11	13	20	36		
	1200V A	6	8	10	10	15		
	1500V A	3	4	5	6	8		
	2 Pole in Serie + 2 Pole parallel A2+2	500V A	29	45	58	72	85	
		600V A	29	45	50	64	80	
		700V A	16	23	27	35	55	
		800V A	16	20	23	30	45	
		900V A	13	16	20	25	35	
		1000V A	9	11	13	20	25	
1200V A		6	8	10	10	15		
1500V A		3	4	5	6	8		
3 Pole in Serie + 2 Pole parallel A3+2		500V A	29	45	58	-	-	
		600V A	29	45	50	-	-	
	700V A	29	38	45	-	-		
	800V A	29	38	45	-	-		
	900V A	29	38	45	-	-		
	1000V A	29	38	45	-	-		
	1200V A	12	14	16	-	-		
	1500V A	9	11	13	-	-		
	4 Pole in Serie A4	500V A	16	25	32	40	55	
		600V A	16	25	32	40	55	
700V A		16	25	32	40	55		
800V A		16	25	32	40	55		
900V A		16	25	32	40	55		
1000V A		16	25	32	40	55		
1200V A		16	25	32	40	55		
1500V A		16	20	23	30	40		
4 Pole in Serie + 2 Pole parallel A4+2		500V A	29	45	58	-	-	
		600V A	29	45	58	-	-	
	700V A	29	45	58	-	-		
	800V A	29	45	58	-	-		
	900V A	29	45	58	-	-		
	1000V A	29	45	58	-	-		
	1200V A	29	45	50	-	-		
	1500V A	16	20	23	-	-		
	<b>Bemessungsstrom <math>I_e</math></b>							
	<b>AC21B</b>	A2, A4 $U_e$ max. 440V	A	16	25	32	40	55
A2+2 $U_e$ max. 440V		A	29	45	58	72	85	

1) Gilt für: Überspannungskategorie I bis III, Verschmutzungsgrad 3 (Norm-Industrie):  $U_{imp} = 8kV$ .

2) Gilt für: Überspannungskategorie I bis III, Verschmutzungsgrad 2 (min. IP55):  $U_{imp} = 8kV$ .

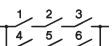
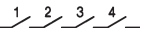
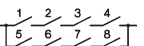

# Technische Daten

Daten nach IEC 60947-3, VDE 0660, GB14048.3 (CCC China)

Hauptkontakte		Type	LS16	LS25	LS32	LS40	LS55	
<b>Bemessungsbetriebsstrom I<sub>e</sub></b> <b>DC-PV1</b>	1 Pol	300V	A	16	23	27	40	55
		400V	A	14	22	25	33	44
	A1 	500V	A	10	17	20	24	32
		600V	A	7	12	15	19	25
		700V	A	5	6	7	12	18
		800V	A	3	4	5	10	13
		900V	A	3	3	4	8	10
		1000V	A	2	2	3	5	8
		2 Pole in Serie A2 	500V	A	16	25	32	40
	600V		A	16	25	32	40	55
	700V		A	16	27	32	35	55
	800V		A	16	19	21	37	55
	900V		A	16	17	18	31	43
	1000V		A	10	11,5	13	29	36
	1100V		A	8	10	11,5	19	25
1200V	A		7	8,5	10	11	17	
1300V	A		6	7	8	10	14	
1400V	A		5	6	7	9	12	
1500V	A	3	5	6	7,5	10		
2 Pole in Serie + 2 Pole parallel A2+2 	500V	A	29	45	58	72	85	
	600V	A	29	36	55	68	85	
	700V	A	22	27	32	49	77	
	800V	A	17	19	21	42	63	
	900V	A	16	17	18	31	43	
	1000V	A	10	11,5	13	23	36	
	1100V	A	8	10	11,5	17	25	
	1200V	A	7	8,5	10	11	17	
	1300V	A	6	7	8	10	14	
	1400V	A	5	6	7	9	12	
1500V	A	3	5	6	8	10		
3 Pole in Serie + 2 Pole parallel A3+2 	500V	A	29	45	58	-	-	
	600V	A	29	45	58	-	-	
	700V	A	29	43	55	-	-	
	800V	A	29	40	51	-	-	
	900V	A	29	38	47	-	-	
	1000V	A	29	38	45	-	-	
	1100V	A	19	27	37	-	-	
	1200V	A	17	25	28	-	-	
	1300V	A	15	21	25	-	-	
	1400V	A	12	18	22	-	-	
1500V	A	10	14	20	-	-		
4 Pole in Serie A4 	500V	A	16	25	32	40	55	
	600V	A	16	25	32	40	55	
	700V	A	16	25	32	40	55	
	800V	A	16	25	32	40	55	
	900V	A	16	25	32	40	55	
	1000V	A	16	25	32	40	55	
	1100V	A	16	25	32	40	55	
	1200V	A	16	25	32	40	55	
	1300V	A	16	25	32	40	55	
	1400V	A	16	25	32	40	55	
1500V	A	16	25	32	40	55		
4 Pole in Serie + 2 Pole parallel A4+2 	500V	A	29	45	58	-	-	
	600V	A	29	45	58	-	-	
	700V	A	29	45	58	-	-	
	800V	A	29	45	58	-	-	
	900V	A	29	45	58	-	-	
	1000V	A	29	45	58	-	-	
	1100V	A	29	45	54	60	68	
	1200V	A	29	45	50	56	65	
	1300V	A	26	39	44	50	61	
	1400V	A	23	33	38	46	58	
1500V	A	20	26	32	42	55		

# Technische Daten

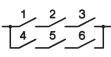
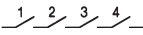
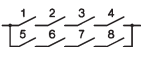

Daten nach IEC 60947-3, VDE 0660, GB14048.3 (CCC China)

Hauptkontakte	Type	LS16	LS25	LS32	LS40	LS55		
<b>Bemessungsbetriebsstrom I<sub>b</sub></b> <b>DC-PV2</b> 1 pole A1 	300V	A	16	23	27	40	55	
	400V	A	15	18	20	30	40	
	500V	A	10	12	14	19	25	
	600V	A	5	6	8	10	13	
	700V	A	1,5	2	3	7	10	
	800V	A	1,5	2	3	6	8	
	900V	A	1	1,5	2,0	5	6	
	1000V	A	1	1,5	2,0	3	4	
	2 poles in series A2 	500V	A	16	25	32	40	55
		600V	A	14	21	27	40	55
		700V	A	13	19	22	35	55
		800V	A	12	15	17	33	49
		900V	A	8	10	12	25	35
		1000V	A	4	5	6	16	20
		1100V	A	83	4	5	11	15
		1200V	A	2	3	4	8	12
		1300V	A	1,5	2	3	7	10
		1400V	A	1	2	3	7	9
1500V		A	1	1,5	2	6	8	
2 poles in series + 2 poles parallel A2+2 		500V	A	25	39	50	72	85
	600V	A	20	32	35	60	75	
	700V	A	13	19	22	38	60	
	800V	A	12	15	17	33	49	
	900V	A	8	10	12	25	35	
	1000V	A	4	5	6	16	25	
	1100V	A	3	4	5	10	15	
	1200V	A	2	3	4	8	12	
	1300V	A	1,5	2	3	7	10	
	1400V	A	1	2	3	7	9	
	1500V	A	1	1,5	2	6	8	
	3 poles in series + 2 poles parallel A3+2 	500V	A	-	-	-	-	-
600V		A	-	-	-	-	-	
700V		A	-	-	-	-	-	
800V		A	-	-	-	-	-	
900V		A	-	-	-	-	-	
1000V		A	-	-	-	-	-	
1100V		A	13	15	17	-	-	
1200V		A	11	13	15	-	-	
1300V		A	8	11	13	-	-	
1400V		A	6	8	10	-	-	
1500V		A	4	6	8	-	-	
4 poles in series A4 		500V	A	16	25	32	40	55
	600V	A	16	25	32	40	55	
	700V	A	16	25	32	40	55	
	800V	A	16	25	32	40	55	
	900V	A	16	25	32	40	55	
	1000V	A	16	25	32	40	55	
	1100V	A	15	25	32	40	55	
	1200V	A	13,5	21	27	40	55	
	1300V	A	12	19	24	36	50	
	1400V	A	10,5	16	21	33	45	
	1500V	A	9	14	18	30	40	
	4 poles in series + 2 poles parallel A4+2 	500V	A	-	-	-	-	-
600V		A	-	-	-	-	-	
700V		A	-	-	-	-	-	
800V		A	-	-	-	-	-	
900V		A	-	-	-	-	-	
1000V		A	-	-	-	-	-	
1100V		A	15	23	30	44	59	
1200V		A	13,5	21	27	40	55	
1300V		A	12	19	24	36	50	
1400V		A	10,5	16	21	33	45	
1500V		A	9	14	18	30	40	

Schütze, Motorstarter  
Leistungsschalter  
Motorschutzschalter  
Schalter  
AC-Hauptschalter  
DC-Lasttrennschalter  
Befehls- und Meldegeräte  
Vertretungen, Bezugsquellen

# Technische Daten





Daten nach IEC 60947-3, VDE 0660, GB14048.3 (  China)

Hauptkontakte		Typ	LS16	LS25	LS32	LS40	LS55
<b>Bemessungsbetriebsstrom I<sub>e</sub></b> <b>DC22B</b>	500V	A	1	1,25	1,5	x	2,5
	1 Pol	A	0,5	0,75	1	x	2,0
	A1	A	0,3	0,4	0,5	x	1,5
		A	0,15	0,2	0,25	x	1,0
	1000V	A	-	-	-	x	x
	1200V	A	-	-	-	x	x
	1500V	A	-	-	-	x	x
	2 Pole in Serie	A	7	8	9	x	x
	A2	A	5,5	6	6,5	x	x
		A	2	2,5	3	x	x
	800V	A	-	-	-	x	x
	1000V	A	1	1,5	2	x	x
	1200V	A	-	-	-	x	x
	1500V	A	-	-	-	x	x
	4 Pole in Serie	A	16	25	32	x	x
A4	A	16	25	27,5	x	x	
	A	11,5	12	12,5	x	x	
800V	A	-	-	-	x	x	
1000V	A	8	9	10	x	x	
1200V	A	-	-	-	x	x	
1500V	A	-	-	-	x	x	
<b>Bedingter Bemessungskurzschlußstrom</b>		kA <sub>eff</sub>	5	5	5	10	10
Maximale Vorsicherung	gL (gG)	A	40	63	80	125	160
Mechanische Lebensdauer		x10 <sup>3</sup>	10	10	10	10	10
Bemessungskurzzeitstromfestigkeit (1s)	I <sub>CW</sub>	A2, A4, A6, A8	800	900	1000	A2, A4: 1200	A2, A4: 1400
		A2+2, A3+2, A4+2	1300	1500	1700	A2+2: 2000	A2+2: 2400
Bemessungskurzschluß-einschaltvermögen	I <sub>CM</sub>	A2, A4, A6, A8	800	900	1000	A2, A4: 1200	A2, A4: 1400
		A2+2, A3+2, A4+2	1300	1500	1700	A2+2: 2000	A2+2: 2400
<b>Anschlußquerschnitte</b> (inkl. Verbinder)	ein- oder mehrdrähtig	mm <sup>2</sup>	LSV-B1 4 - 16	LSV-B1 4 - 16	LSV-B1 4 - 16	LSV-B2 2,5 - 25	LSV-B2 2,5 - 25
	feindrähtig	mm <sup>2</sup>	4 - 10	4 - 10	4 - 10	2,5 - 16	2,5 - 16
	feindrähtig (+ Aderendhülse)	mm <sup>2</sup>	4 - 10	4 - 10	4 - 10	1,5 - 16	1,5 - 16
Klemmschraube		Nm	M4 Pz2	M4 Pz2	M4 Pz2	M5 Pz2	M5 Pz2
Anzugsdrehmoment		Nm	1,7 - 1,8	1,7 - 1,8	1,7 - 1,8	2,5 - 2,8	2,5 - 2,8
2 Leiter pro Klemme ohne Verbinder LSV-B1 / LSV-B2							
ein- oder mehrdrähtig		mm <sup>2</sup>	16+(1,5-2,5) / 10+(1,5-6) / 6+(1,5-10) / 4+(1,5-10)			16+(1,5-2,5) / 10+(1,5-10) / 6+(1,5-10) / 4+(1,5-10)	
feindrähtig & feindrähtig + Aderendhülse		mm <sup>2</sup>	16+(1,5-2,5) / 10+(1,5-4) / 6+(1,5-6)			16+(1,5-6) / 10+(1,5-10) / 6+(1,5-16) / 4+(1,5-16)	
stranded		AWG	8+(16-12) / 10+(16-10) / 12+(16-8) 14+(16-8)			3+(18-10) / 4+(18-10) / 6+(18-8) 8+(18-8)	
solid		AWG	10+(16-12) / 12+(16-10) 14+(16-10)			10+(16-10) / 12+(16-10) / 14+(16-10) 12+(16-10) / 14+(16-10)	
<b>Zulässige Umgebungstemperatur</b>							
Betrieb	offen	°C			-40 to +65		
	gekapselt	°C			-40 to +45		
Lagerung		°C			-50 to +90		
<b>Verlustleistung</b> pro Schalter bei I <sub>e max.</sub> DC21B / AC21B							
A2		W	0,8	2	3	4	6
A4		W	1,6	4	6	8	12
A6		W	2,4	6	9	12	18
A8		W	3,2	8	12	16	24
A2+2		W	0,4	1	1,5	2	3
A3+2		W	0,6	1,5	2,25	3	4,5
A4+2		W	0,8	2	3	4	6

x zur Approbation eingereicht



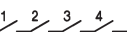
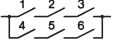
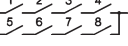

# Technische Daten

Daten nach UL508  File E359344, und UL508  File E332938, Category no.: NRNT2, NRNT8

Typ			LS16	LS25	LS32	LS40	LS55	
 1 Pol "General use" DC	350V	A	4	5	6	7,1	10,0	
	500V	A	4	5	6	5,7	7,0	
	600V	A	4	5	6	5,0	5,8	
	700V	A	-	-	-	3,9	5,0	
	800V	A	-	-	-	3,2	4,4	
	900V	A	-	-	-	2,5	3,5	
	1000V	A	-	-	-	1,5	2,0	
	 2 Pole in Serie A2	350V	A	16	20	32	40	55
		500V	A	16	20	32	40	55
		600V	A	16	20	32	40	55
700V		A	-	-	-	32	46	
800V		A	-	-	-	26	37	
900V		A	-	-	-	20	28	
1000V		A	-	-	-	16	20	
 2 Pole in Serie + 2 Pole parallel A2+2		350V	A	29	45	58	72	85
		400V	A	-	-	-	67	79
		500V	A	29	38	40	53	66
	600V	A	21	23	32	42	55	
	700V	A	-	-	-	35	47	
	800V	A	-	-	-	30	40	
	900V	A	-	-	-	26	32	
	1000V	A	-	-	-	22	25	
	 4 Pole in Serie A4	350V	A	16	25	32	40	55
		500V	A	16	25	32	40	55
600V		A	16	25	32	40	55	
700V		A	-	-	-	40	55	
800V		A	-	-	-	40	55	
900V		A	-	-	-	40	55	
1000V		A	-	-	-	40	55	
 3 Pole in Serie + 2 Pole parallel A3+2		350V	A	29	45	58	-	-
		500V	A	29	38	50	-	-
		600V	A	21	38	45	-	-
 4 Pole in Serie + 2 Pole parallel A4+2	350V	A	29	45	58	-	-	
	500V	A	29	45	58	-	-	
	600V	A	29	45	50	-	-	
AC-Rating "General use"								
2 Pole in Serie		600V	A	16	25	32	40	55
2 Pole in Serie + 2 Pole parallel		277V	A	-	-	50	72	85
3 Pole parallel		3x480V	A	-	-	32	-	-
Fuse size (RK5) Industrial Control Switch								
5kA / 600V		A	40	60	80	-	-	
5kA/1000V		A	-	-	-	160	160	
<b>Anschlußquerschnitte</b> (inkl. Verbinder LSV-B1)								
ein- oder mehrdrähtig		AWG	12 - 10	12 - 10	12 - 10	16 - 10	16 - 10	
feindrähtig		AWG	12 - 6	12 - 6	12 - 6	14 - 4	14 - 4	
feindrähtig (+ Aderendhülse)		AWG	12 - 6	12 - 6	12 - 6			
Klemmschraube			M4 Pz2	M4 Pz2	M4 Pz2	M5 Pz2	M5 Pz2	
Anzugsdrehmoment		lb.inch	9 - 16	9 - 16	9 - 16	22 - 25	22 - 25	
Schutzart der Anschlußklemmen <sup>1)</sup>			IP20	IP20	IP20	IP20	IP20	

1) Schutzart der Anschlußklemmen mit angeschlossenem, isoliertem Leiter.

## Approbationen

Land	USA, UL508 	US, Kanada UL508 	Europa 	TÜVRheinland 	China CCC 	CB-Zertifikate
Typ						
LS16	o	o	/	o	o	o
LS25	o	o	/	o	o	o
LS32	o	o	/	o	o	o
LS40	o	o	/	x	x	o
LS55	o	o	/	x	x	o

o In Normalausführung approbiert / Approbation nicht erforderlich CE x zur Approbation eingereicht  
 - bisher nicht zur Approbation vorgesehen

# Technische Daten

Maximal zulässiger Strom, abhängig von Umgebungstemperatur und Anschlußquerschnitten

Schalter LS16..., 2 Kontakte in Serie, offen

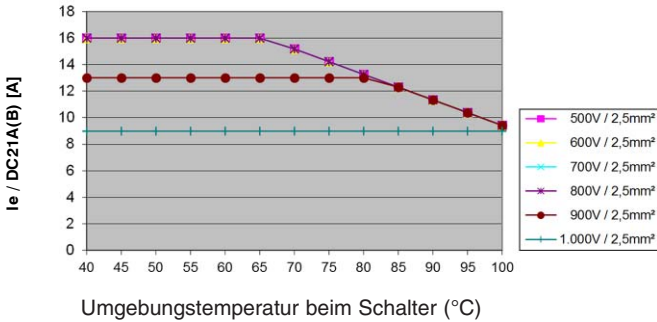

Schalter LS16 ..., 2 Kontakte in Serie + 2 parallel, offen

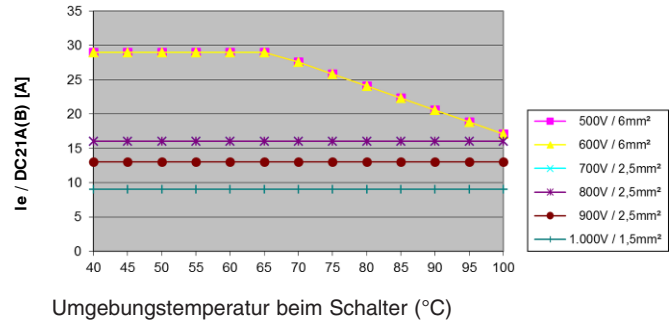

Schalter LS16..., 4 Kontakte in Serie, offen

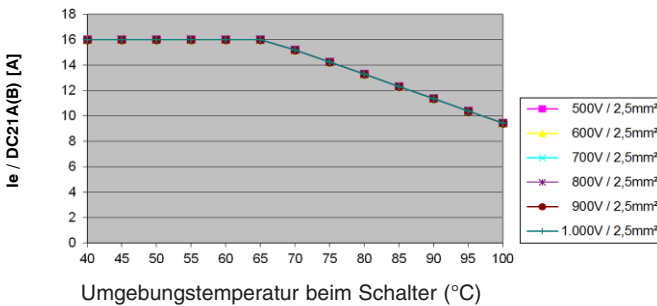

Schalter LS16... 4 Kontakte in Serie + 2 parallel, offen

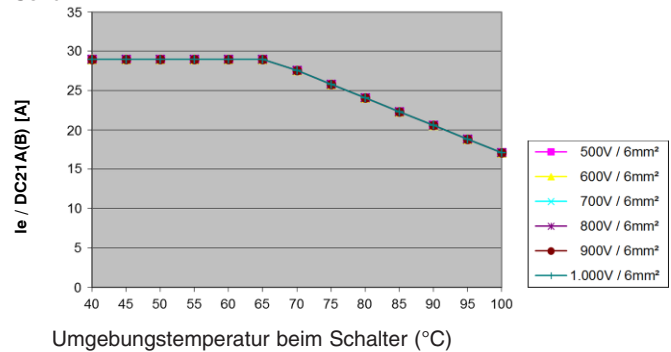

Schalter gekapselt LS16 PFL..., 2 Kontakte in Serie

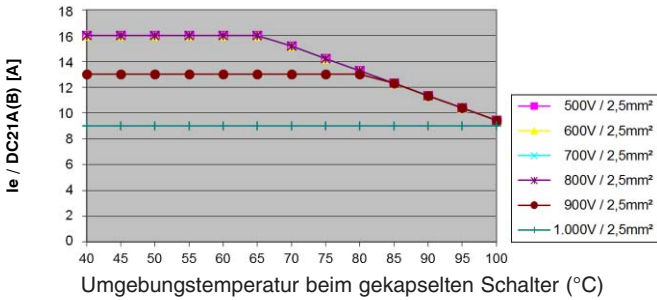

Schalter gekapselt LS16 PFL..., 2 Kontakte in Serie + 2 parallel

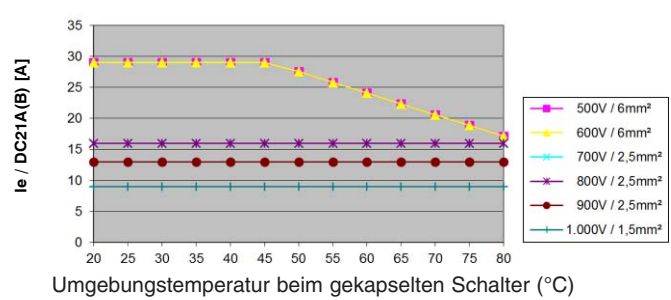

Schalter gekapselt LS16 PFL..., 4 Kontakte in Serie

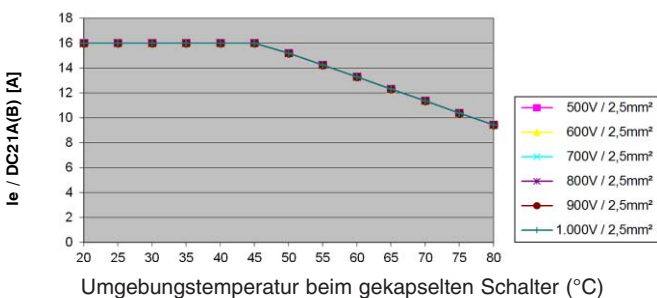

Schalter gekapselt LS16 PFL..., 4 Kontakte in Serie + 2 parallel

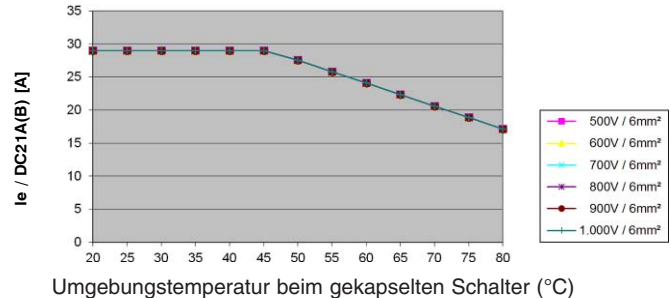

# Technische Daten

Maximal zulässiger Strom, abhängig von Umgebungstemperatur und Anschlußquerschnitten

Schalter LS25..., 2 Kontakte in Serie, offen

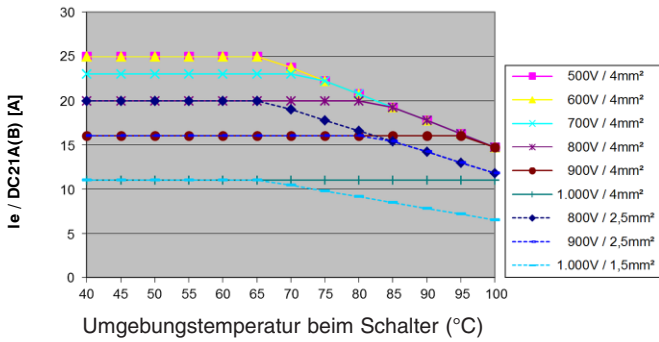

Schalter LS25 ..., 2 Kontakte in Serie + 2 parallel, offen

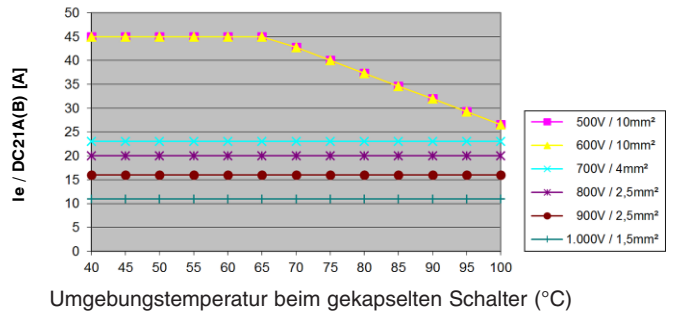

Schalter LS25..., 4 Kontakte in Serie, offen

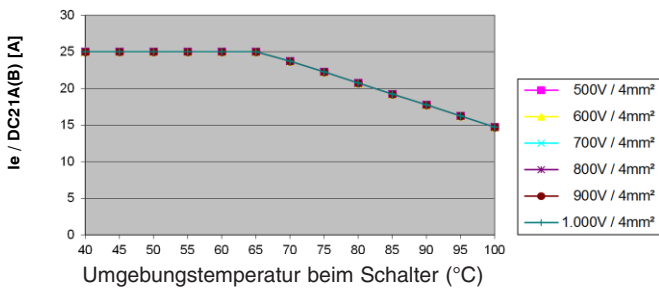

Schalter LS25..., 4 Kontakte in Serie + 2 parallel, offen

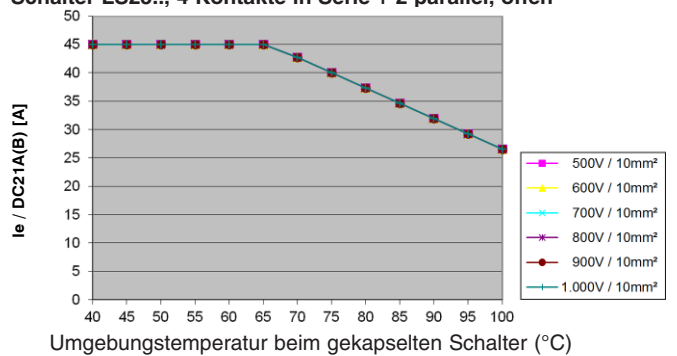

Schalter gekapselt LS25 PFL..., 2 Kontakte in Serie

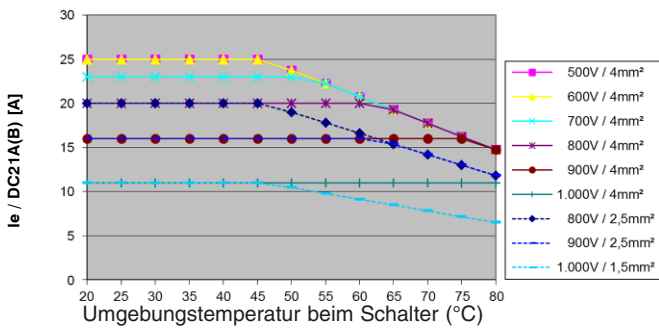

Schalter gekapselt LS25 PFL..., 2 Kontakte in Serie + 2 parallel

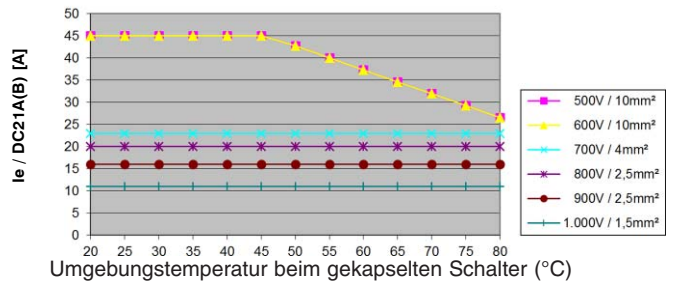

Schalter gekapselt LS25 PFL..., 4 Kontakte in Serie

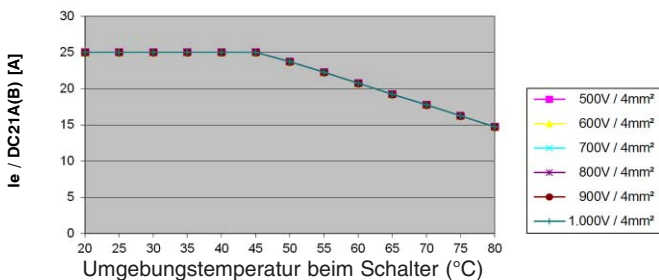

Schalter gekapselt LS25PFL..., 4 Kontakte in Serie + 2 parallel

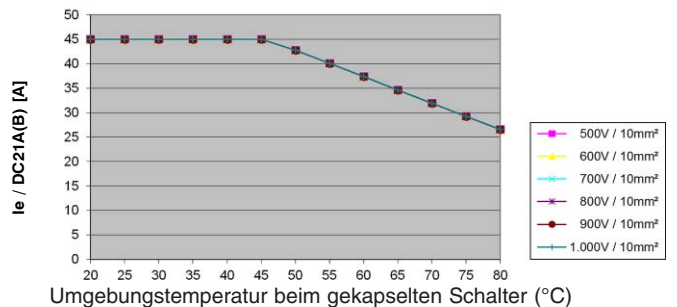

# Technische Daten

## Maximal zulässiger Strom, abhängig von Umgebungstemperatur und Anschlußquerschnitten

Schalter LS32..., 2 Kontakte in Serie, offen

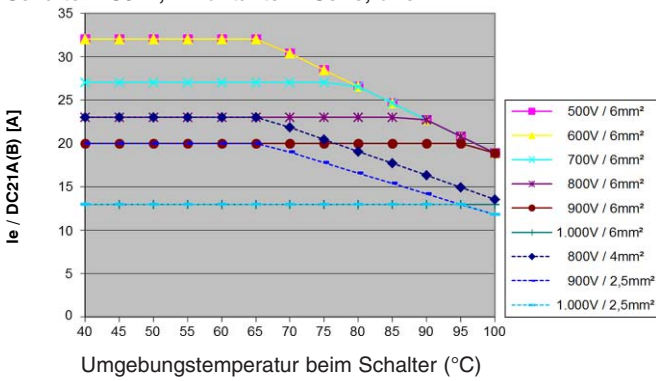

Schalter LS32 ..., 2 Kontakte in Serie + 2 parallel, offen

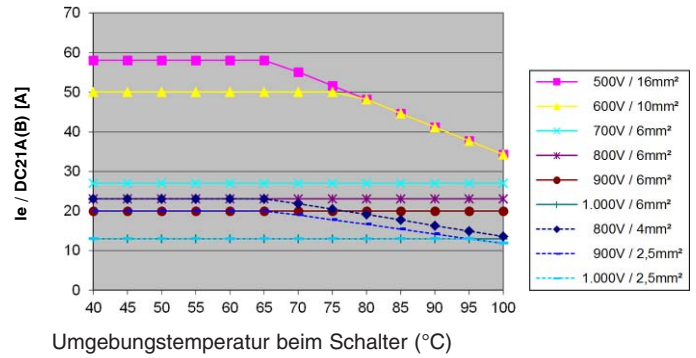

Schalter LS32..., 4 Kontakte in Serie, offen

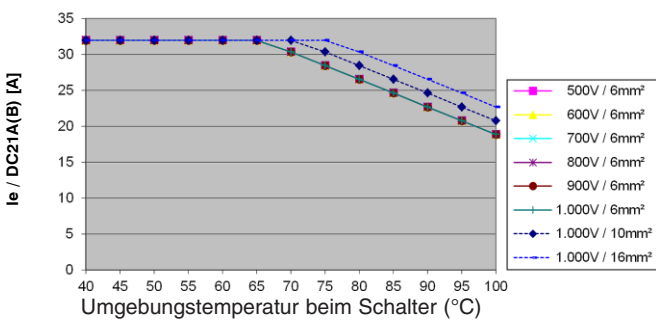

Schalter LS32..., 4 Kontakte in Serie + 2 parallel, offen

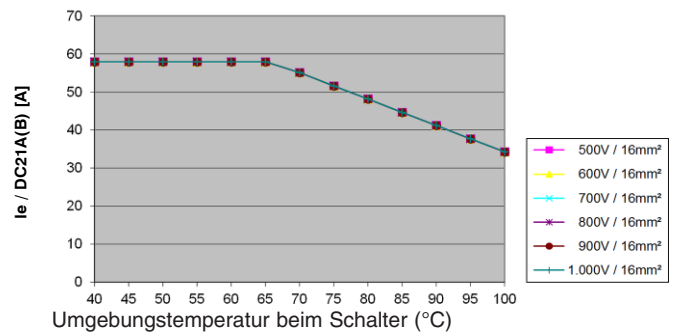

Schalter gekapselt LS32 PFL..., 2 Kontakte in Serie

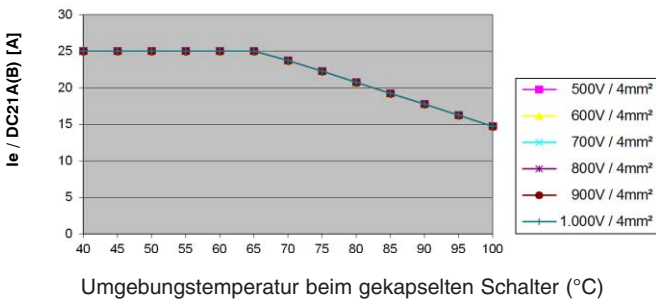

Schalter gekapselt LS32 PFL..., 2 Kontakte in Serie + 2 parallel

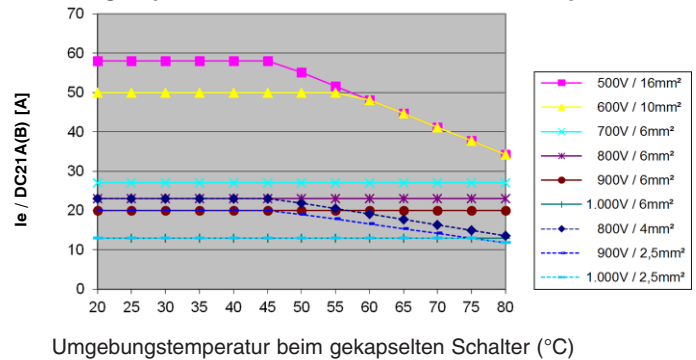

Schalter gekapselt LS32 PFL..., 4 Kontakte in Serie

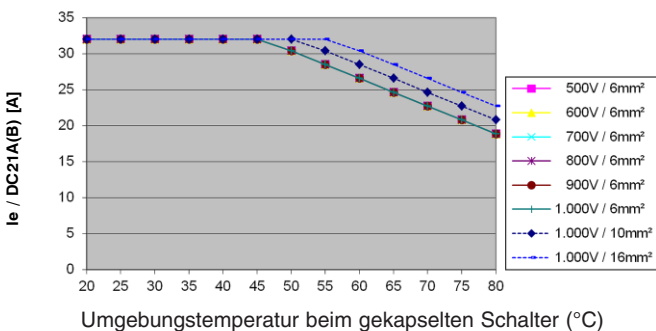

Schalter gekapselt LS32PFL..., 4 Kontakte in Serie + 2 parallel

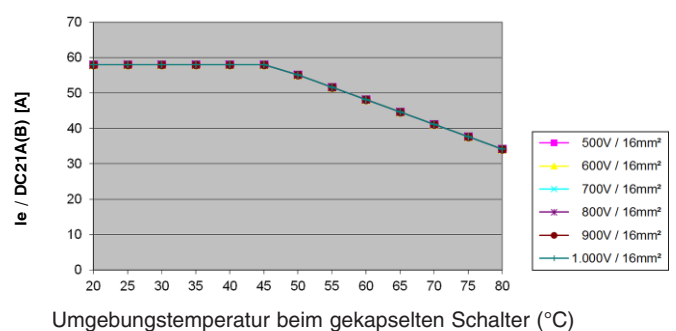

# Technische Daten

Maximal zulässiger Strom, abhängig von Umgebungstemperatur und Anschlußquerschnitten

Schalter LS40..., 2 Kontakte in Serie, offen

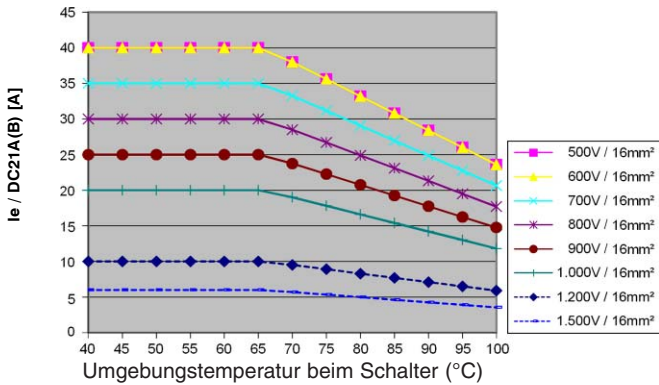

Schalter LS40 ..., 2 Kontakte in Serie + 2 parallel, offen

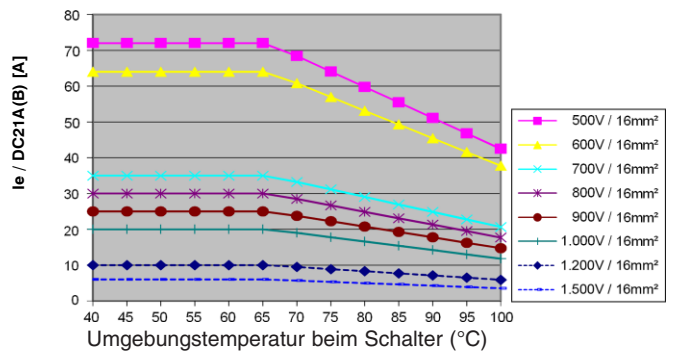

Schalter LS40..., 4 Kontakte in Serie, offen

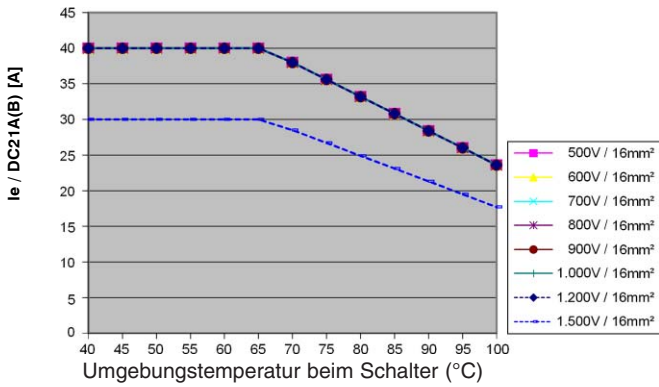

Schalter gekapselt LS40 PFL..., 4 Kontakte in Serie

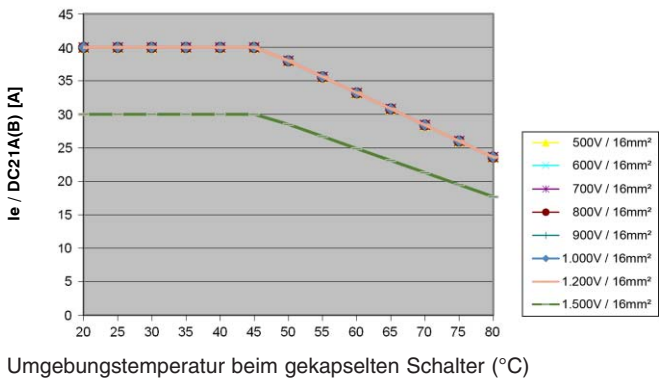

Umgebungstemperatur beim gekapselten Schalter (°C)

# Technische Daten

Maximal zulässiger Strom, abhängig von Umgebungstemperatur und Anschlußquerschnitten

Schalter LS55..., 2 Kontakte in Serie, offen

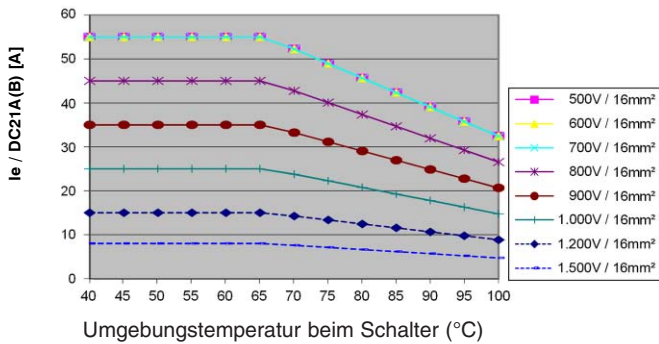

Schalter LS55 ..., 2 Kontakte in Serie + 2 parallel, offen

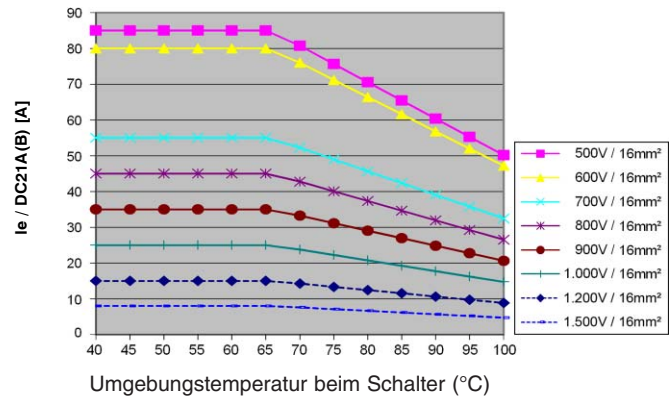

Schalter LS55..., 4 Kontakte in Serie, offen

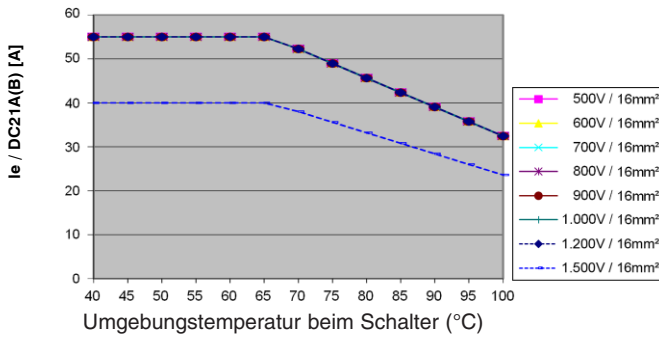

Schalter gekapselt LS55 PFL..., 4 Kontakte in Serie

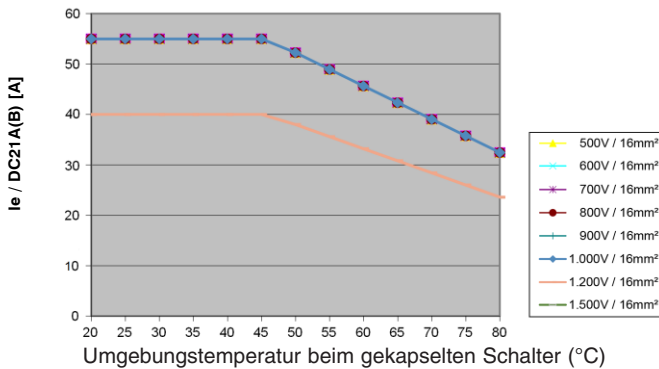

**Abmessungen**

LS16 E..., LS25 E..., LS32 E..., ..A2

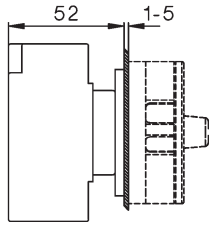

..A2+2, ..A4.

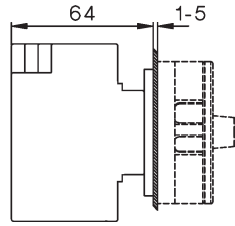
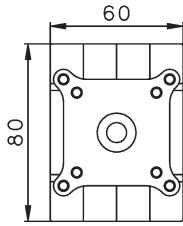

LS... +WW"x"  
Verlängerte Schalterwelle

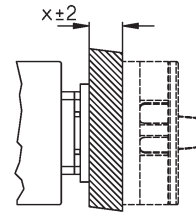

LS16 E..., LS25 E..., LS32 E..., ..A6, ..A8, ..A3+2, ..A4+2

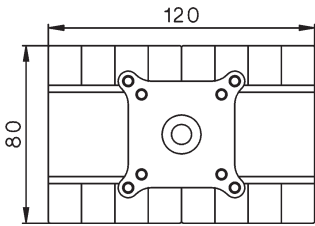

LS40 E..., LS55 E...  
..A2, ..A2+2, ..A4.

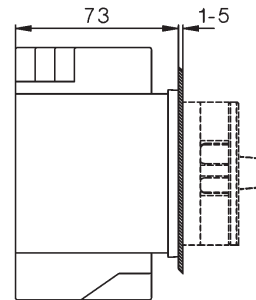
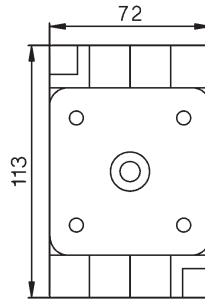
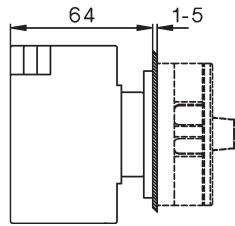

Bohrplan

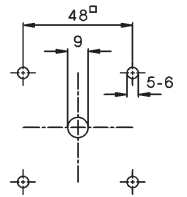

Schild 64□  
Griff

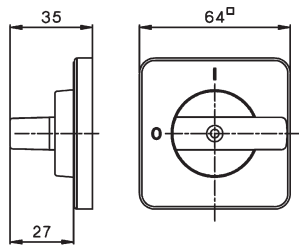

Sperrvorrichtung SV1.

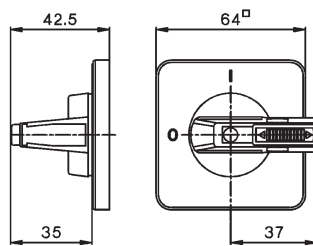

Sperrvorrichtung SV4.

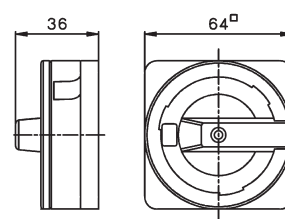

LS16 Z..., LS25 Z..., LS32 Z..., ..A2

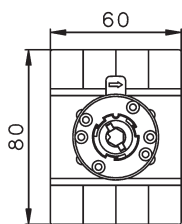

..A2+2, ..A4.

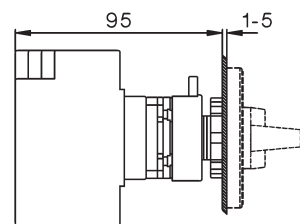
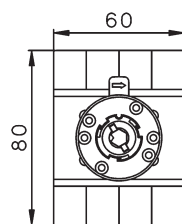
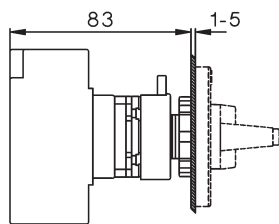

Bohrplan

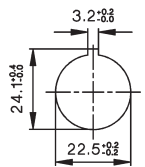

Schild 48□  
Griff

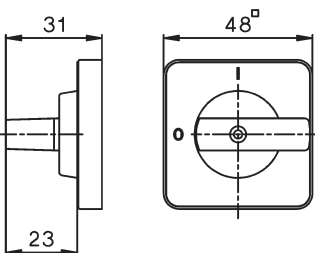

Sperrvorrichtung SV1.

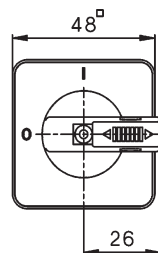
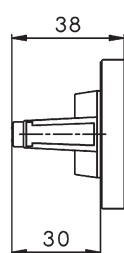

## Abmessungen

LS16 Z.., LS25 Z.., LS32 Z..,  
..A6, ..A8, ..A3+2, ..A4+2

LS.. ZO.. LS.. ZOH1..,

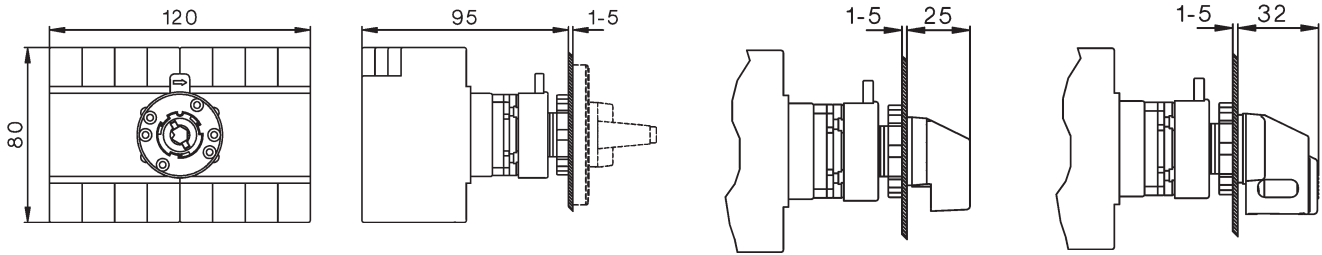

LS16 VZV.., LS25 VZV.., LS32 VZV..,

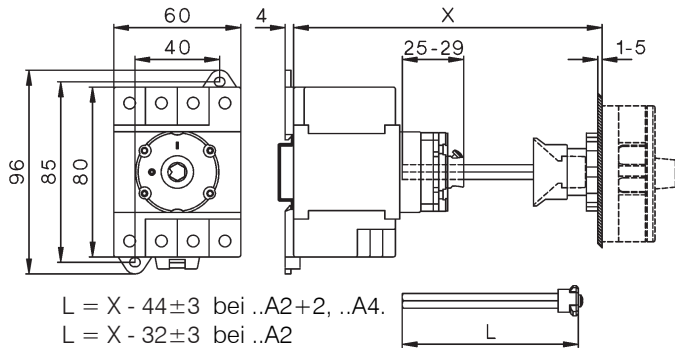

Lieferlänge bei: ..A2+2, ..A4.  
 $X_{max.} = 194, L = 150$   
( $X_{min.} = 89$ )

Lieferlänge bei: ..A2  
 $X_{max.} = 182, L = 150$   
( $X_{min.} = 77$ )

größere X-Maße auf Anfrage

$L = X - 44 \pm 3$  bei ..A2+2, ..A4.  
 $L = X - 32 \pm 3$  bei ..A2

LS16 VZV.., LS25 VZV.., LS32 VZV..,  
..A6, ..A8, ..A3+2, ..A4+2

Bohrplan

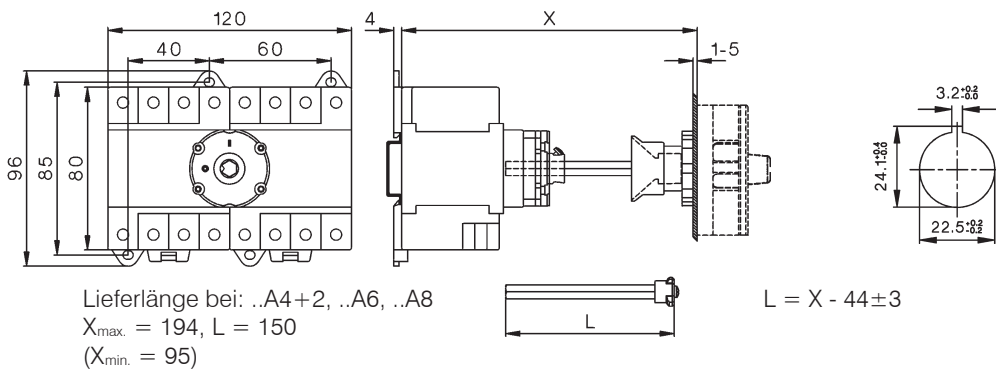

Lieferlänge bei: ..A4+2, ..A6, ..A8  
 $X_{max.} = 194, L = 150$   
( $X_{min.} = 95$ )

$L = X - 44 \pm 3$

LS40 VZV.., LS55 VZV..  
..A2, ..A2+2, ..A4.

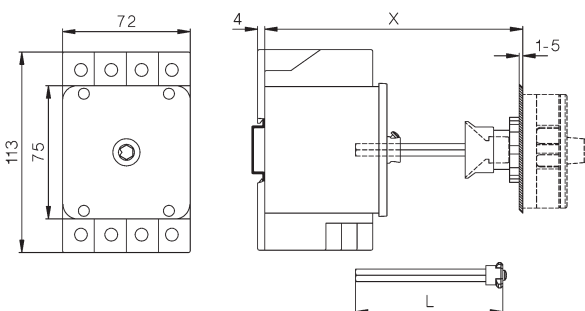

$X_{max.} = 194, L = 133$   
( $X_{min.} = 103$ )

$L = X - 61 \pm 3$

## Abmessungen

LS16 SMA..., LS25 SMA..., LS32 SMA...,  
..A2 ..

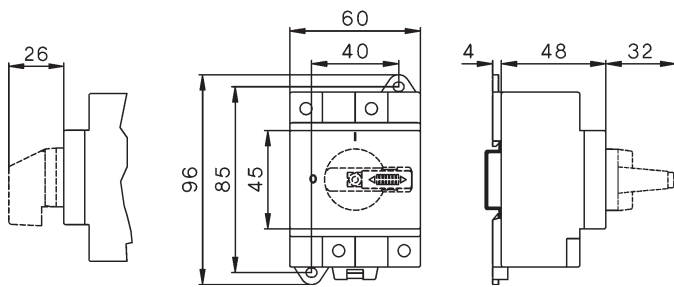

A2+2, ..A4.

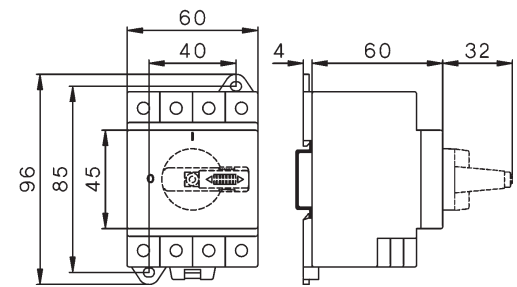

LS40 SMA..., LS55 SMA..  
..A2, ..A2+2, ..A4.

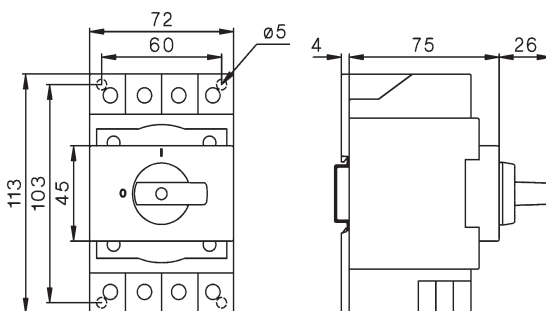

LS16 SMA..., LS25 SMA..., LS32 SMA...,  
..A6, ..A8, ..A3+2, ..A4+2

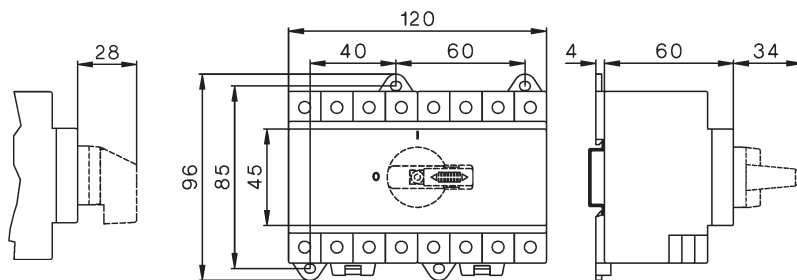

LS.. SMAH1.. mit niedrigem Griff  
A2+SV1N

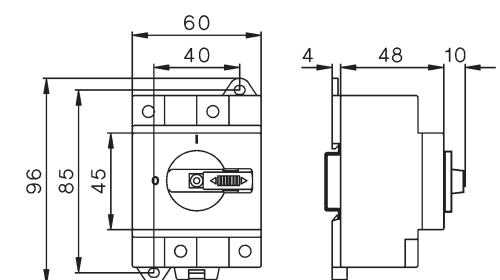

LS16 SMAH1..., LS25 SMAH1, LS32 SMAH1 mit niedrigem Griff  
A2+2 +SV1N, A4.+SV1N

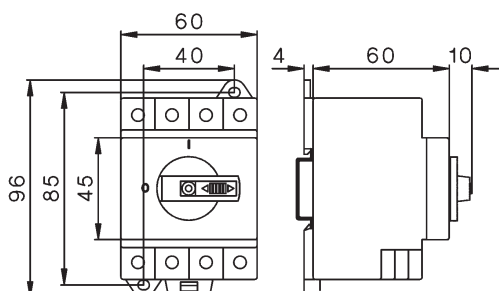

A4+2 +SV1N, A6+SV1N, A8+SV1N

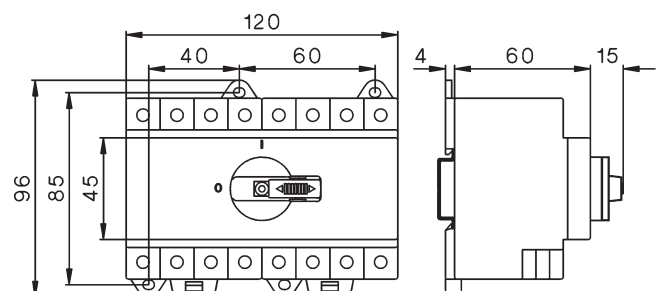

## Abmessungen

LS16 PFL..., LS25 PFL..., LS32 PFL..  
..A2, ..A2+2, ..A4.

Hauptschalter (versperbar)  
LS..PFLH4 A..

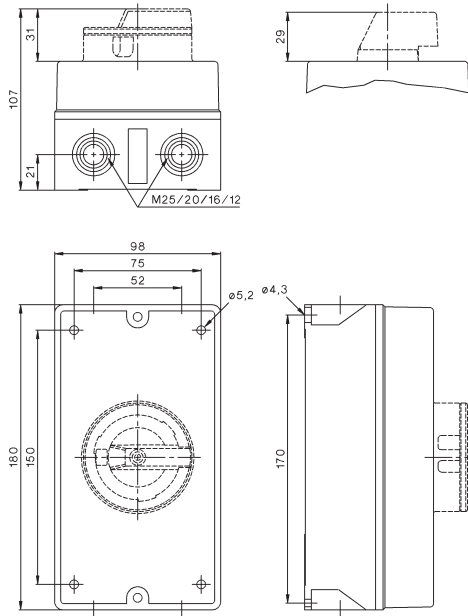

LS16 PFL..., LS25 PFL..., LS32 PFL..  
..A2, ..A2+2, ..A4.  
+ M25

Hauptschalter (versperbar)  
LS..PFLH4 A..

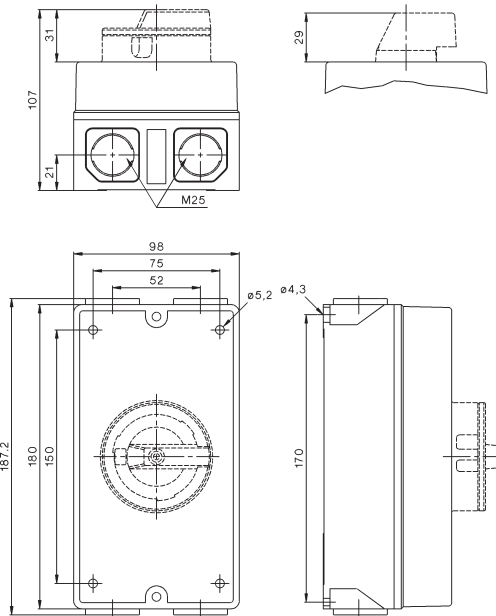

LS16 PF., LS25 PF., LS32 PF..  
..A6, ..A8, ..A3+2, ..A4+2  
Hauptschalter (versperbar)  
LS..PFH4 A..

LS40 PF., LS55 PF..  
A2, A2+2, A4

