



YASKAWA AC Drive-V1000 Option

CANopen

Technical Manual

Type SI-S3/V

To properly use the product, read this manual thoroughly and retain for easy reference, inspection, and maintenance. Ensure the end user receives this manual.

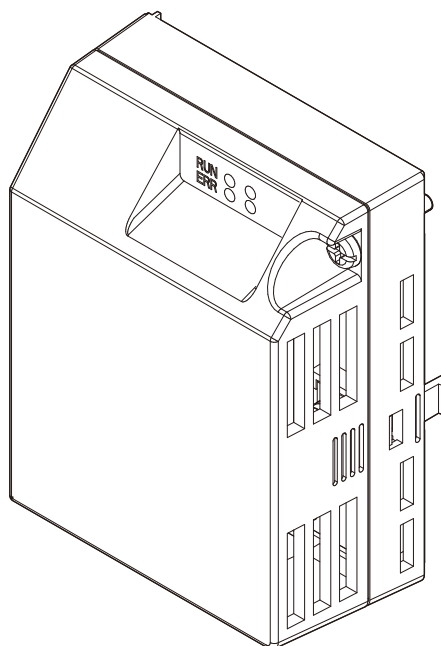

Copyright © 2007 YASKAWA ELECTRIC CORPORATION

All rights reserved. No part of this publication may be reproduced, stored in a retrieval system, or transmitted, in any form or by any means, mechanical, electronic, photocopying, recording, or otherwise, without the prior written permission of Yaskawa. No patent liability is assumed with respect to the use of the information contained herein. Moreover, because Yaskawa is constantly striving to improve its high-quality products, the information contained in this manual is subject to change without notice. Every precaution has been taken in the preparation of this manual. Yaskawa assumes no responsibility for errors or omissions. Neither is any liability assumed for damages resulting from the use of the information contained in this publication.

Table of Contents

1 PREFACE AND SAFETY	4
2 PRODUCT OVERVIEW	7
3 RECEIVING	8
4 CANOPEN OPTION COMPONENTS	9
5 INSTALLATION PROCEDURE	12
6 RELATED PARAMETERS	16
7 BIT RATE AND NODE ID SETUP	17
8 OBJECT DICTIONARY	18
9 CONFIGURING MANUFACTURER SPECIFIC OBJECTS	29
10 PROCESS DATA OBJECTS (PDO)	30
11 DRIVE PARAMETER, MONITOR AND CONTROL REGISTER ACCESS	33
12 FAULT DIAGNOSIS AND POSSIBLE SOLUTIONS	35
13 SPECIFICATIONS	37

1 Preface and Safety

Yaskawa manufactures products used as components in a wide variety of industrial systems and equipment. The selection and application of Yaskawa products remain the responsibility of the equipment manufacturer or end user. Yaskawa accepts no responsibility for the way its products are incorporated into the final system design. Under no circumstances should any Yaskawa product be incorporated into any product or design as the exclusive or sole safety control. Without exception, all controls should be designed to detect faults dynamically and fail safely under all circumstances. All systems or equipment designed to incorporate a product manufactured by Yaskawa must be supplied to the end user with appropriate warnings and instructions as to the safe use and operation of that part. Any warnings provided by Yaskawa must be promptly provided to the end user. Yaskawa offers an express warranty only as to the quality of its products in conforming to standards and specifications published in the Yaskawa manual. NO OTHER WARRANTY, EXPRESS OR IMPLIED, IS OFFERED. Yaskawa assumes no liability for any personal injury, property damage, losses, or claims arising from misapplication of its products.

◆ Applicable Documentation

The following manuals are available for SI-S3/V CANopen Option unit:

Option Unit

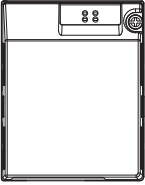
	V1000 Option CANopen Installation Manual Manual No. : TOBPC73060024
	Read this manual first. The installation manual is packaged with the CANopen Option and contains a basic overview of wiring, settings, functions, and fault diagnoses.
	V1000 Option CANopen Technical Manual (this book) Manual No. : SIEPC73060024
	The technical manual contains detailed information. To obtain the technical manual access these sites: Europe: http://www.yaskawa.eu.com Japan: http://www.e-mechatronics.com Other areas: contact a Yaskawa representative.

For the drive setup, refer to one of the documentation listed below.

Yaskawa Drive

	V1000 Series AC Drive Technical Manual
	This manual describes installation, wiring, operation procedures, functions, troubleshooting, maintenance, and inspections to perform before operation. To obtain instruction manuals for Yaskawa products access these sites: Europe: http://www.yaskawa.eu.com Japan: http://www.e-mechatronics.com Other areas: contact a Yaskawa representative
	V1000 Series AC Drive Quick Start Guide
	This guide is packaged together with the product. It contains basic information required to install and wire the drive. This guide provides basic programming and simple set-up and adjustment.

◆ Terms

Note: Indicates supplementary information that Yaskawa highly recommends be followed, even though equipment may not be at risk.

Drive: Yaskawa AC Drive -V1000 Series

CANopen Option: Yaskawa AC Drive -SI-S3/V CANopen option unit for the Yaskawa V1000 drive

◆ Registered Trademarks

- CANopen is a registered trademark of the CAN in Automation (CiA).
- Other company names and product names listed in this manual are registered trademarks of those companies.

◆ Supplemental Safety Information

Read and understand this manual before installing, operating, or servicing this option unit. The option unit must be installed according to this manual and local codes.

The following conventions are used to indicate safety messages in this manual. Failure to heed these messages could result in serious or possibly even fatal injury or damage to the products or to related equipment and systems.

DANGER

Indicates a hazardous situation, which, if not avoided, will result in death or serious injury.

WARNING

Indicates a hazardous situation, which, if not avoided, could result in death or serious injury.

CAUTION

Indicates a hazardous situation, which, if not avoided, could result in minor or moderate injury.

NOTICE

Indicates an equipment damage message.

■ General Safety

General Precautions

- The diagrams in this section may include option units and drives without covers or safety shields to illustrate details. Be sure to reinstall covers or shields before operating any devices. The option board should be used according to the instructions described in this manual.
- Any illustrations, photographs, or examples used in this manual are provided as examples only and may not apply to all products to which this manual is applicable.
- The products and specifications described in this manual or the content and presentation of the manual may be changed without notice to improve the product and/or the manual.
- When ordering a new copy of the manual due to damage or loss, contact your Yaskawa representative or the nearest Yaskawa sales office and provide the manual number shown on the front cover.

DANGER

Heed the safety messages in this manual.

Failure to comply will result in death or serious injury.

The operating company is responsible for any injuries or equipment damage resulting from failure to heed the warnings in this manual.

NOTICE

Do not modify the drive circuitry.

Failure to comply could result in damage to the drive and will void warranty.

YASKAWA is not responsible for any modification of the product made by the user. This product must not be modified.

Do not expose the drive to halogen group disinfectants.

Failure to comply may cause damage to the electrical components in the option unit.

Do not pack the drive in wooden materials that have been fumigated or sterilized.

Do not sterilize the entire package after the product is packed.

■ Option Unit Label Warnings

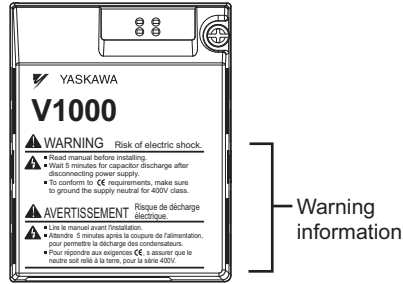

Warning information is displayed on the option unit as shown in the figure below. Follow all warnings and safety instructions when using the product.

When using the drive in an area that may require displaying warning information in Japanese or Chinese, a sticker is provided with the CANopen Option. This sticker can be placed over the English and French warnings on the front of the CANopen Option.





■ Warning Contents

WARNING Risk of electric shock.

-  ■ Read manual before installing.
-  ■ Wait 5 minutes for capacitor discharge after disconnecting power supply.
- To conform to **CE** requirements, make sure to ground the supply neutral for 400V class.

AVERTISSEMENT Risque de décharge électrique.

-  ■ Lire le manuel avant l'installation.
-  ■ Attendre 5 minutes après la coupure de l'alimentation, pour permettre la décharge des condensateurs.
- Pour répondre aux exigences **CE**, s'assurer que le neutre soit relié à la terre, pour la série 400V.

2 Product Overview

◆ About This Product

The CANopen Option (Model: SI-S3/V) is an option unit designed to connect the V1000 drive to a CANopen network. Using this option unit a CANopen master can

- Operate the drive
- Monitor the drive operation status
- Read or modify drive parameters

The CANopen Option supports the following communication profiles

- DS 301 Ver. 4.02
- DSP 402 Ver. 1.1 Velocity Mode

◆ Applicable Models

The CANopen Option can be used with the drive models in [Table 1](#).

Table 1 Applicable Models

Drive	Software Version <1>
CIMR-V□□A□□□□BA□	5010, 1010 or later
CIMR-V□□A□□□□FA□	5010, 1010 or later
CIMR-V□□A□□□□JA□	5010, 1010 or later

<1> See “PRG” on the drive nameplate for the software version number.

3 Receiving

Please perform the following tasks after receiving the CANopen Option:

- Inspect the CANopen Option for damage.
If the CANopen Option appears damaged upon receipt, contact the shipper immediately.
- Verify receipt of the correct model by checking the information on the nameplate (see [Figure 1](#)).
- If you have received the wrong model or the CANopen Option does not function properly, contact your supplier.

◆ Contents and Packaging

Table 2 Contents of Package

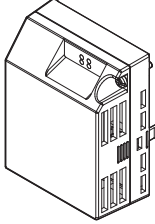
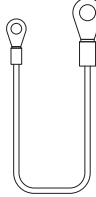
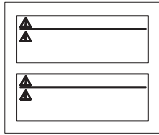
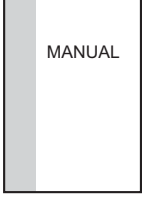
Description:	Option Unit	Ground Wire	Warning Labels	Installation Manual
-				
Quantity:	1	4	1	1

◆ Tool Requirements

A Phillips screwdriver (M3, M3.5 to M6 <1>) metric or (#1, #2 <1>) U.S. standard size is required to install the CANopen Option.

<1> Screw sizes vary by drive capacity. Select a screwdriver that matches the drive capacity.

Note: Tools required to prepare CANopen cables for wiring are not listed in this manual.

4 CANopen Option Components

◆ CANopen Option

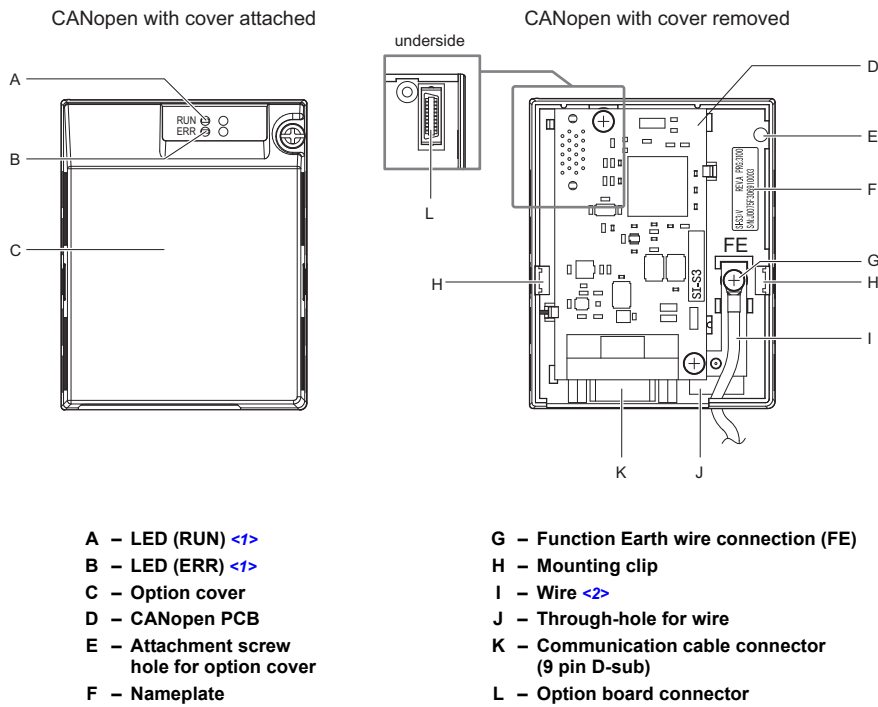

<1> Refer to *CANopen Option Status LEDs on page 11* for details on the LEDs.
 <2> Wires are not connected to the CANopen Option and are packaged separately in the box.

Figure 1 Option Unit

◆ Dimensions

The installed CANopen Option adds 27 mm (1.06 in.) to the total depth of the drive.

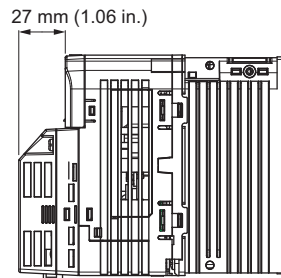

Figure 2 Dimensions

4 CANopen Option Components

◆ Communication Connector

The CANopen Option is connected to the network using a 9 pin D-sub connector. The connector location is illustrated in [Figure 3](#), the pin assignment is explained in [Table 3](#).

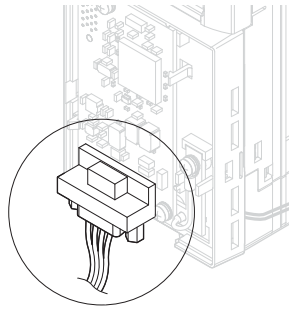

Figure 3 Communication connector location

Table 3 Communication connector (9 pin D-sub)

CANopen Connector	Pin	Signal	Description
	1	–	–
	2	CAN_L	CAN_L bus line (dominant low)
	3	CAN_GND	CAN Ground
	4	–	–
	5	CAN_SHLD	CAN shield
	6	–	–
	7	CAN_H	CAN_H bus line (dominant high)
	8	–	–
	9	–	–
	–	CAN_SHLD	CAN shield

◆ CANopen Option Status LEDs

The CANopen Option has two LEDs that indicate the option unit or communication status. The indications are conform with the DS303, Part 3: Indicator Specification.

Table 4 Understanding the Status LEDs

LED	Color	Display	Meaning
RUN	Green	On	Operational State
		Blinking	Pre-Operational State
		Single flash	Stopped
		Flickering < >	Automatic bit rate detection in progress (alternately flickering with ERR LED)
ERR	Red	On	Bus off
		Blinking	Bus initialization failed (parameter setting error)
		Single flash	Fault has occurred Receiving CAN error frame (too many error frames)
		Double flash	Guard / Heartbeat event has occurred
		Flickering < >	Automatic bit rate detection in progress (alternately flickering with RUN LED)
		Off	Online

<|> Available in option unit software version 3102 and later.

Figure 4 explains the indicator flash rates.

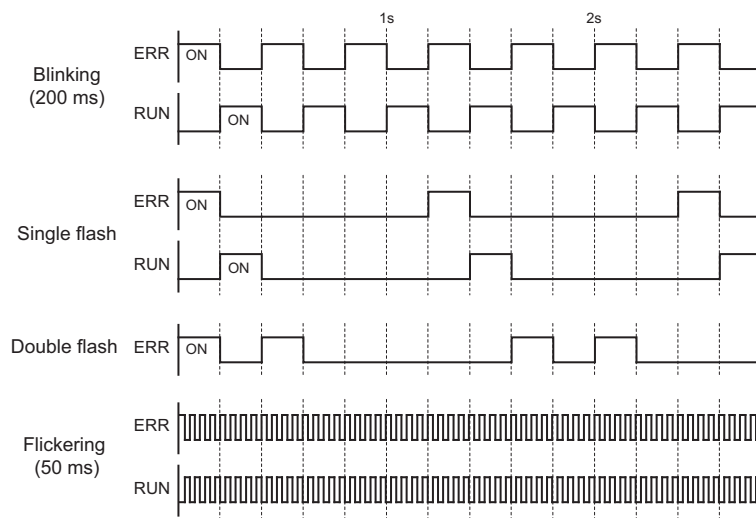

Figure 4 LED Flash Rates and Meaning

5 Installation Procedure

◆ Section Safety

DANGER

Electrical Shock Hazard

Do not connect or disconnect wiring while the power is on.

Failure to comply will result in death or serious injury.

Disconnect all power to the drive, wait at least five minutes after all indicators are off, measure the DC bus voltage to confirm safe level, and check for unsafe voltages before servicing to prevent electric shock. The internal capacitor remains charged even after the power supply is turned off. The charge indicator LED will extinguish when the DC bus voltage is below 50 Vdc.

WARNING

Electrical Shock Hazard

Do not remove the option board cover while the power is on.

Failure to comply could result in death or serious injury.

The diagrams in this section may include option units and drives without covers or safety shields to show details. Be sure to reinstall covers or shields before operating any devices. The option board should be used according to the instructions described in this manual.

Do not allow unqualified personnel to use equipment.

Failure to comply could result in death or serious injury.

Maintenance, inspection, and replacement of parts must be performed only by authorized personnel familiar with installation, adjustment, and maintenance of this product.

Do not use damaged wires, place excessive stress on wiring, or damage the wire insulation.

Failure to comply could result in death or serious injury.

Fire Hazard

Tighten all terminal screws to the specified tightening torque.

Loose electrical connections could result in death or serious injury by fire due to overheating of electrical connections.

NOTICE

Damage to Equipment

Observe proper electrostatic discharge procedures (ESD) when handling the option unit, drive, and circuit boards.

Failure to comply may result in ESD damage to circuitry.

Never shut the power off while the drive is outputting voltage.

Failure to comply may cause the application to operate incorrectly or damage the drive.

Do not operate damaged equipment.

Failure to comply may cause further damage to the equipment.

Do not connect or operate any equipment with visible damage or missing parts.

Do not use unshielded cable for control wiring.

Failure to comply may cause electrical interference resulting in poor system performance.

Use shielded twisted-pair wires and ground the shield to the ground terminal of the drive.

Properly connect all pins and connectors.

Failure to comply may prevent proper operation and possibly damage equipment.

Check wiring to ensure that all connections are correct after installing the option unit and connecting any other devices.

Failure to comply may result in damage to the option unit.

◆ Prior to Installing the Option Unit

Prior to installing the CANopen Option, wire the drive and make necessary connections to the drive terminals. Refer to the V1000 Quick Start Guide for information on wiring and connecting the drive. Verify that the drive runs normally without the option installed.

◆ Installing the CANopen Option

Remove the front cover of the drive before installing the CANopen Option. Follow the directions below for proper installation.

1. Switch off the power supply to the drive.

DANGER! Electrical Shock Hazard - Do not connect or disconnect wiring while the power is on. Failure to comply will result in death or serious injury. Before installing the CANopen Option, disconnect all power to the drive. The internal capacitor remains charged even after the power supply is turned off. The charge indicator LED will extinguish when the DC bus voltage is below 50 Vdc. To prevent electric shock, wait at least five minutes after all indicators are off and measure the DC bus voltage level to confirm safe level.

2. Remove the front cover.
The original drive front cover may be discarded because it will be replaced by the CANopen Option cover in step 8.

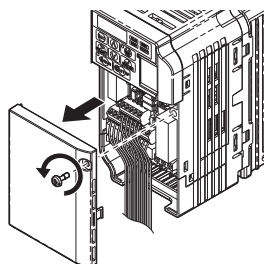

Figure 5 Remove Front Cover

3. Remove the bottom cover and connect the CANopen Option ground wire to the ground terminal.

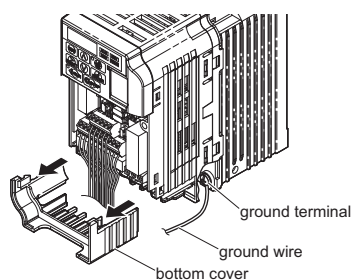
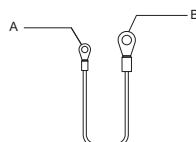

Figure 6 Connect Ground Wire

Note: The four different ground wires packaged with the CANopen Option connect the unit to different models. Select the proper ground wire from the CANopen Option kit depending on drive size.



- A** – Option unit connection: screw size = M3
B – Drive-side connection: screw size = M3.5 to M6

Figure 7 Ground Wire

Note: Cover removal for certain larger models with a Terminal Cover:

- Single-Phase 200 V Class: CIMR-V□BA0006 to BA0018
- Three-Phase 200 V Class: CIMR-V□2A0008 (for Japan and Asia), CIMR-V□2A0010 (for the other regions) to 2A0069
- Three-Phase 400 V Class: All models

Remove the terminal cover before removing the bottom cover to install the CANopen Option ground wire. Replace the terminal cover after wiring the CANopen Option ground wire.

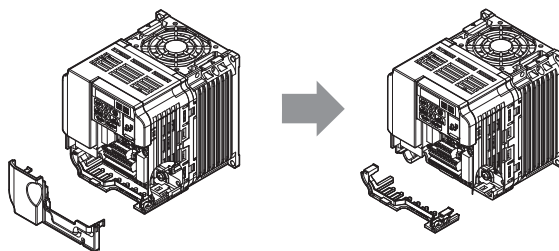

Figure 8 Models with Terminal Cover

4. Reattach the bottom cover.

5 Installation Procedure

5. Connect the CANopen Option to the drive. Properly secure the tabs on the left and right sides of the CANopen Option to the drive case.

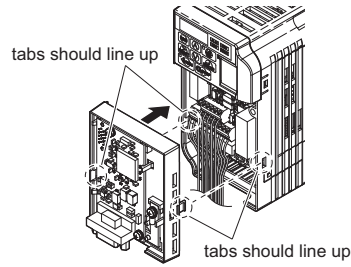

Figure 9 Attach CANopen Option

6. Connect the ground wire from the drive ground terminal to the CANopen Option ground. When wiring the CANopen Option, pass the ground wire through the inside of the drive bottom cover, then pass the ground wire into the through-hole at the front of the CANopen Option.

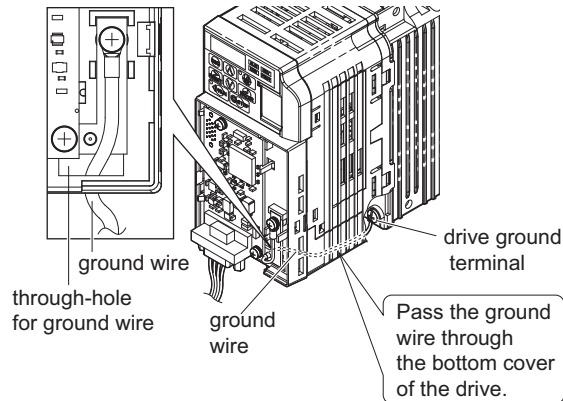

Figure 10 Ground Wire Connection

7. Connect the communications cable to the terminal block.
8. Attach the CANopen Option cover to the front of the CANopen Option.

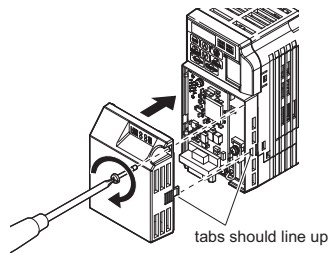

Figure 11 Attach Cover

Note: When using the drive in an area that may require displaying warning information in Japanese or Chinese, a sticker has been provided with the CANopen Option. This sticker can be placed over the English and French warnings on the front of the CANopen Option.

◆ Communication Cable Specifications

To ensure proper performance Yaskawa recommends using CANopen dedicated communication cables only.

◆ Wiring the CANopen Option

The CANopen option must be connected to the network using a 9 pin D-sub connector wired like shown in [Figure 12](#).

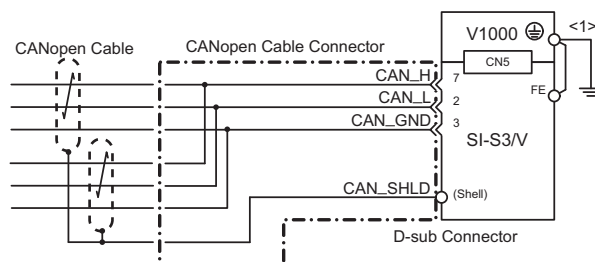

<1> The FE terminal on the CANopen Option must be connected to the drive ground terminal using one of the 4 delivered ground wires.

Figure 12 Wiring Diagram

◆ Termination

Both ends of a CANopen bus system have to be terminated with a 120 Ω resistor. As the CANopen Option has no build in terminating resistor, make sure to apply a terminating resistor as shown in [Figure 13](#) if the CANopen Option is the last node in the network.

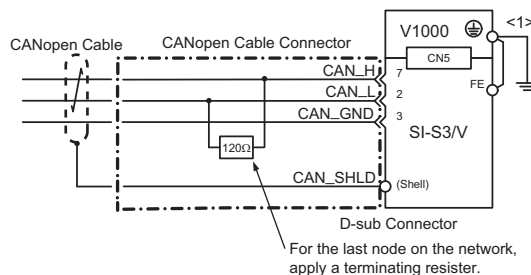

<1> The FE terminal on the CANopen Option must be connected to the drive ground terminal using one of the 4 delivered ground wires.

Figure 13 Termination Resistor Installation

◆ EDS Files

For easy network implementation of drives equipped with a CANopen Option, an EDS file can be obtained from:

Europe: <http://www.yaskawa.eu.com>

Japan: <http://www.e-mechatronics.com>

Other areas: contact a Yaskawa representative

6 Related Parameters

The following parameters are used to set up the drive for operation with the option.

Confirm proper setting of the all parameters in [Table 5](#) before starting network communications.

Table 5 Related Parameters

No.	Name	Description	Default
b1-01 <1>	Frequency Reference Selection	Selects the frequency reference input source 0: Operator - Digital preset speed d1-01 to d1-17 1: Terminals - Analog input terminal A1 or A2 2: MEMOBUS/Modbus Communications 3: Option Card 4: Pulse Input (Terminal RP)	<2>
b1-02 <3>	Run Command Selection	Selects the run command input source 0: Digital Operator - RUN and STOP keys 1: Digital input terminals S□ 2: MEMOBUS/Modbus Communications 3: Option Card	1
E2-04 <2>	Motor 1 Motor Poles	Set the number of motor poles described on the motor nameplate. 2 to 48	4
F6-01	Operation Selection after Communications Error	Determines drive response when a bUS error is detected during communications with the CANopen Option 0: Ramp to Stop 1: Coast to Stop 2: Fast-Stop 3: Alarm Only <4>	1
F6-02	External Fault Detection Conditions (EF0)	Sets the condition for external fault detection (EF0) 0: Always detected 1: Detected only during operation	0
F6-03	Stopping Method for External Fault from Communication Option Board	Determines drive response for external fault input (EF0) detection during CANopen communication 0: Ramp to Stop 1: Coast to Stop 2: Fast-Stop 3: Alarm Only <4>	1
F6-07 <5>	NetRef/ComRef Selection Function	0: Multi-step speed reference disabled (F7 mode) 1: Multi-step speed reference allowed (V7 mode)	1
F6-08 <5>	Reset Communication Related Parameters	Determines if communication-related parameters are set back to their original default values when the drive is initialized. 0: Do not reset F6-□□ and F7-□□ parameters when the drive is initialized using parameter A1-03. 1: Rest F6-□□ and F7-□□ parameters when the drive is initialized using parameter A1-03. Note: Setting this parameter does not affect communication-related parameters.	0
F6-35 <6> <7>	Node Address	0 to 126	<8>
F6-36 <7>	Communication Speed	0: Automatic Bit Rate Detection <9> 1: 10 kbps 2: 20 kbps 3: 50 kbps 4: 125 kbps 5: 250 kbps 6: 500 kbps 7: 800 kbps 8: 1 Mbps	<10>
o1-03 <11>	Digital Operator Display Selection	Sets the units to display the frequency reference and output frequency. 0: 0.01 Hz 1: 0.01% (100% = E1-04) 2: r/min (enter the number of motor poles to E2-04/E4-04/E5-04) 3: User defined by parameters o1-10 and o1-11	<2>

- <1> To start and stop the drive from a CANopen master device using serial communications, set b1-02 to 3. To control the frequency reference of the drive via the master device, set b1-01 to 3.
- <2> The default value depends on the drive used and the drive software version. For details refer to the technical manual for the drive.
- <3> E2-04 is necessary to set up when the Drive Profile DSP402 objects are used.
- <4> If set to 3, then the drive will continue to operate when an EF0 fault is detected. Take proper safety measures, such as installing an emergency stop switch.
- <5> Drive software versions 1012 and later have F6-07 and F6-08 both set to 1.
- <6> Power must be cycled in order to activate the setting after changes.
- <7> All node addresses must be unique. If a node address is set to 0, then the ERR light will flash, and AEr will appear on the keypad screen to indicate that an address setting error has occurred.
- <8> Default setting is 99 for drive software versions 5010, 1010, and 1011, 0 for software version 1012 or later.
- <9> Disabled in option unit software versions up to 3101. Automatic bit rate detection is available in option unit software versions 3102 and later.
- <10> For the models CIMR-VC□A, the default value is 0 when using the drive software version S1018 and later.
For the other models, the default value is 6.
- <11> Changing o1-03 changes the units for input object 2010 (Hex) (frequency reference), output object 2110 (Hex) (output frequency) and 2200 (Hex) (motor speed). Furthermore o1-03 must be set to 2 and E2-04 must be set to the correct value in order to use the Drive Profile DSP402.

7 Bit Rate and Node ID Setup

◆ Bit Rate Setup

In order to communicate with the drive, the bit rate set in the SI-S3/V option unit must match the bit rate used in the network. The bit rate can be selected manually by using a drive parameter. The SI-S3/V can also be set up for automatic bit rate detection.

■ Setting the Bit Rate Manually

Select the correct bit rate in drive parameter F6-36. After changing F6-36, cycle the drive power supply to enable the changes.

Table 6 Bit Rate Setting

No.	Name	Description	Default
F6-36	Communication Speed	0: Automatic Bit Rate Detection </> 1: 10 kbps 2: 20 kbps 3: 50 kbps 4: 125 kbps 5: 250 kbps 6: 500 kbps 7: 800 kbps 8: 1 Mbps	</>

<1> Disabled in option unit software versions up to 3101. Automatic bit rate detection is available in option unit software versions 3102 and later.

<2> For the models CIMR-VC□A, the default value is 0 when using the drive software version S1018 and later.
For the other models, the default value is 6.

■ Using Automatic Bit Rate Detection

Note: This function is available in option unit software version 3102 and later.

Set drive parameter F6-36 to 0 to enable automatic bit rate detection and cycle the drive power supply.

When set to automatic bit rate detection, after power up the SI-S3/V will listen to messages on the bus and adjust its bit rate setting automatically. When the bit rate is found the SI-S3/V will enter pre-operational status and transmit a boot up message containing the drive's node ID. The SI-S3/V will not send any messages until the bit rate is detected.

As long as the automatic bit rate detection is in progress, the RUN and ERR LEDs on the SI-S3/V option unit will flicker alternately.

- Note:**
1. There must be bus traffic that the SI-S3/V can listen to in order to detect the bit rate. If there is low traffic, the bit rate detection might take a long time.
 2. The bit rate detected by the SI-S3/V is not automatically saved. When cycling the drive power supply, the SI-S3/V will perform bit rate detection again.
 3. Besides the master, there must be at least one other node in the network that is set to the correct bit rate. For example, the bit rate cannot be detected if the network consists of a master that is set up for a certain bit rate (controller) and one or multiple drives with an SI-S3/V option unit set to auto bit rate detection.

◆ Node ID Setup

The node ID can be set in drive parameter F6-35. The value range is 1 to 126. Each node ID may only be used once in the network.

After changing F6-35, cycle the drive power supply to enable the changes.

Note: When the node is set to 0, the ERR light will flash and "AEr" will appear on the drive digital operator to indicate that an address setting error has occurred.

8 Object Dictionary

◆ Object Dictionary Overview

The Object Dictionary consists of three sections:

- Communication Profile Objects
- Manufacturer Specific Profile Objects
- Drive and Motion Profile Objects

The tables below provide an overview of the communication objects available in the SI-S3/V option unit. Refer to the page references given for further details on each object.

■ Communication Profile Objects (DS 301)

Index (Hex)	Name	Page
1000	Device Type	19
1001	Error Register	19
1003	Pre-defined Error Field	20
1005	COB-ID SYNC Message	21
1008	Manufacturer Device Name	21
1009	Manufacturer Hardware Version	21
100A	Manufacturer Software Version	21
100C	Guard Time	21
100D	Life Time Factor	21
100E	Node Guarding Identifier	21
1010	Store Parameters	21
1011	Restore Default Parameters	21
1014	COB-ID Emergency Object	21
1016	Consumer Heartbeat Time	22
1017	Producer Heartbeat Time	22
1018	Identity Object	22

■ Manufacturer Specific Profile Objects (DS 301)

Index (Hex)	Content	Page	
Input	2000	Operation Command	22
	2010	Speed Command	22
	2020	Torque Limit	23
	2030	Torque Compensation	23
	2040	MEMOBUS/Modbus Read Command	23
	2050	MEMOBUS/Modbus Write Command	23
	2060	MEMOBUS/Modbus Unlimited Enter Command	23
	2070	MEMOBUS/Modbus Limited Enter Command	23
	2080 <I>	Freely selectable (default: none)	24
	2090 <I>	Freely selectable (default: none)	24
	20A0 <I>	Freely selectable (default: none)	24
	20B0 <I>	Freely selectable (default: none)	24
	20C0 <I>	Freely selectable (default: none)	24
	3000 <I>	Freely selectable (default: none)	24
3100 <I>	Freely selectable (default: none)	24	

Index (Hex)	Content	Page
2100	Drive Status	24
2101 <1>	Drive Status (Change of State filter support)	24
2110	Output Frequency	24
2111 <1>	Output Frequency (Change of State filter support)	24
2120	Output Current	25
2121 <1>	Output Current (Change of State filter support)	25
2130	Output Torque	25
2131 <1>	Output Torque (Change of State filter support)	25
2140	MEMOBUS/Modbus Read Command Response	25
2150	MEMOBUS/Modbus Write Command Response	25
2155 <1>	PDO Parameter Write Response	25
2160	MEMOBUS/Modbus Not Limited Enter Command Response	25
2180 <1>	Freely selectable (default: Input terminal status)	26
2190 <1>	Freely selectable (default: Analog input 1 monitor)	26
21A0 <1>	Freely selectable (default: none)	26
21B0 <1>	Freely selectable (default: none)	26
21C0 <1>	Freely selectable (default: none)	26
21D0 <1>	Freely selectable (default: none)	26
21E0 <1>	Freely selectable (default: none)	26
21F0 <1>	Freely selectable (default: none)	26
2200	Motor Speed <2>	26
2201 <1>	Motor Speed (Change of State filter support) <2>	26

<1> Available in option unit software version 3102 and later.

<2> Units for motor speed are determined by o1-03. If the control mode for the drive is set to V/f control (A1-02=0) and V/f control with simple PG feedback is disabled (H6-01≠3), then the motor speed will be 0.

■ Drives and Motion Profile Objects (DSP 402)

The drive supports the Drive and Motion Profile DSP 402 Velocity Mode. Before using the Velocity Mode objects the following parameters have to be set up in the drive:

- The motor pole number must be set up in E2-04.
- The frequency reference and output frequency display unit has to be set to min^{-1} by setting parameter o1-03 = 2.

If these settings are not done properly, the Velocity Mode objects cannot be used or deliver wrong data.

Object Type	Index (Hex)	Name	Page
Common Entries	60FD	Digital Inputs <1>	28
	60FE	Digital Outputs <2>	28
Device Control	6040	Controlword	26
	6041	Statusword	26
	6061	Modes of operation display	28
Velocity Mode	6042	vl target velocity	27
	6043	vl velocity demand	27
	6044	vl control effort	27
	6046	vl velocity min max amount	27
	6048	vl velocity acceleration	27
	6049	vl velocity deceleration	27
	604A	vl velocity quick stop	27
	604C	vl dimension factor	27
604D	vl pole number	27	

<1> YASKAWA specifies this object as the drive digital output monitor. (Input from the network)

<2> YASKAWA specifies this object as the drive digital inputs. (Output to the network)

◆ Communication Profile Objects (DS 301)

■ 1000 (Hex) - Device Type

This object describes the type of device and its functionality. It is composed of a first 16 bit field that describes the device profile used and a second 16 bit field that gives additional information regarding optional functionality.

Index (Hex)	Subindex	Content	Access	PDO Mapping	Value Range
1000	-	Device type	Read Only	No	Unsigned 32

■ 1001 (Hex) - Error Register

This register shows the fault status of the device. If any errors occurs in the device bit 0 (generic error) is set to one.

Index (Hex)	Subindex	Content	Access	PDO Mapping	Value Range
1001	-	Error register	Read Only	Possible	Unsigned 8

■ 1003 (Hex) - Pre-defined Error Field

This register provides a history of errors that occurred in the drive and have been signaled via the Emergency object. Subindex 0 contains the number of errors. Subindexes 1 to FF contains a rolling list of error codes where subindex 1 always contains the last occurred error. Refer to [Table 7](#) for a list of possible error codes.

Writing a 0 to subindex 0 will reset the error field.

Index (Hex)	Subindex	Content	Access	PDO Mapping	Value Range
1003	0	Number of errors	Read / Write	No	Unsigned 8
	1	Standard error field <1>	Read Only		Unsigned 32

<1> For details of the error codes, refer to [Table 7](#).

Table 7 CANopen Option Unit Error Codes

Error Code (Hex)	Content	Drive Display
2220	Over current	oC
2221	Drive overload	oL2
2310	Motor overload	oL1
2311	Overtorque detection 1	oL3
2312	Overtorque detection 2	oL4
2330	Ground fault	GF
3130	Input phase loss	PF
3210	DC bus overvoltage	ov
3220	DC bus undervoltage	Uv1
3221	DC bus charging circuit fault	Uv3
3300	Output phase loss	LF
4210	Heatsink overheat	oH1
4280	Heatsink overheat	oH
4310	Motor overheat (PTC input)	oH4
4410	Internal braking resistor overheat	rH
5200	Control power supply undervoltage	Uv2
5300	Digital operator disconnected	oPr
5420	Braking transistor fault	rr
5441	External fault 3	EF3
5442	External fault 4	EF4
5443	External fault 5	EF5
5444	External fault 6	EF6
5445 <1>	External fault 7	EF7
5481	Fault input from option unit	EF0
5530	EEPROM error	Err
6301	Error during object content selection	-
7180	Motor over speed (V/f with PG only)	oS
7305	PG fault (V/f with PG only)	PGo
8321	Speed deviation (V/f with PG only)	dEv
FF01	Motor overheat alarm	oH3
FF02	PID feedback lost	FbL
FF03	Undertorque detected 1	UL3
FF04	Undertorque detected 2	UL4
FF05	High slip braking OL	oL7
FF06	Control fault	CF
FF07	BUS error	bUS
FF08	MEMOBUS/Modbus Error	CE
FF0D	External fault at input terminal S1	EF1
FF0E	External fault at input terminal S2	EF2
FF36	Output current imbalance	LF2
FF37	Pullout detection 2	STo
FF3B	Too many speed search restarts	SEr
FF41	PID feedback loss	FbH
FF44	Mechanical weakening detection 1	oL5
FF45	Mechanical weakening detection 2	UL5
FF46	Current offset fault	CoF
FF47	Programming Error 1	PE1
FF49	Current offset fault	dWFL

<1> CIMR-VC □□□□□□ drives do not have terminal S7.

■ 1005 (Hex) - COB-ID SYNC Message

This object defines the COB-ID of the synchronization object (SYNC), and whether the device generates the SYNC message.

Index (Hex)	Subindex	Content	Access	PDO Mapping	Value Range
1005	–	COB-ID SYNC message	Read / Write	No	Unsigned 32

■ 1008 (Hex) - Manufacturer Device Name

This object contains the manufacturer device name.

Index (Hex)	Subindex	Content	Access	PDO Mapping	Value Range
1008	–	Manufacturer device name	Read Only	No	Visible string

■ 1009 (Hex) - Manufacturer Hardware Version

This object contains the manufacturer hardware version.

Index (Hex)	Subindex	Content	Access	PDO Mapping	Value Range
1009	–	Manufacturer hardware version	Read Only	No	Visible string

■ 100A (Hex) - Manufacturer Software Version

This object contains the Manufacturer software version.

Index (Hex)	Subindex	Content	Access	PDO Mapping	Value Range
100A	–	Manufacturer software version	Read Only	No	Visible string

■ 100C (Hex) - Guard Time

This object contains the guard time.

Index (Hex)	Subindex	Content	Access	PDO Mapping	Value Range	Units
100C	–	Guard time	Read / Write	No	Unsigned 16	1 ms

■ 100D (Hex) - Life Time Factor

This object contains the life time factor. Multiplied with the guard time, it sets the time within the SI-S3/V option expects a node guarding message. If the node guarding message is not received an error will be generated.

Index (Hex)	Subindex	Content	Access	PDO Mapping	Value Range
100D	–	Life time factor	Read / Write	No	Unsigned 8

■ 100E (Hex) - Node Guarding Identifier

This object defines the identifier for the node guarding.

Index (Hex)	Subindex	Content	Access	PDO Mapping	Value Range
100E	–	Node guarding identifier	Read Only	No	Unsigned 32

■ 1010 (Hex) - Store Parameters

By writing "save" (s = 73H, a = 61H, v = 76H, e = 65H) to this object, the CANopen Option settings are saved in the non-volatile memory. The CANopen Option will operate using these settings when a Reset Node or Reset Communications command is performed, or when the power supply is cycled.

Index (Hex)	Subindex	Content	Access	PDO Mapping	Value Range
1010	1	Store parameters	Read / Write	No	Unsigned 32

■ 1011 (Hex) - Restore Default Parameters

Writing "load" (l = 6CH, o = 6FH, a = 61H, d = 64H) to this object will restore the CANopen Option default settings.

Index (Hex)	Subindex	Content	Access	PDO Mapping	Value Range
1011	1	Restore default parameters	Read / Write	No	Unsigned 32

■ 1014 (Hex) - COB-ID Emergency Object

This object defines the COB-ID of the emergency object.

Index (Hex)	Subindex	Content	Access	PDO Mapping	Value Range
1014	–	COB-ID emergency object	Read Only	No	Unsigned 32

8 Object Dictionary

■ 1016 (Hex) - Consumer Heartbeat Time

This object defines the Consumer heartbeat time. It must be set to a higher value than the producer heartbeat time set in the master. When set to 0, consumer heartbeat is disabled.

Index (Hex)	Subindex	Content	Access	PDO Mapping	Value Range	Units
1016	1	Consumer heartbeat time	Read / Write	No	Unsigned 32	1 ms

■ 1017 (Hex) - Producer Heartbeat Time

This object determines the cycle time the CANopen Option uses to produce a heartbeat signal. When set to 0, the SI-S3/V does not produce a heartbeat signal.

Index (Hex)	Subindex	Content	Access	PDO Mapping	Value Range	Units
1017	–	Producer heartbeat time	Read / Write	No	Unsigned 16	1 ms

■ 1018 (Hex) - Identity Object

This object contains general information about the drive.

Index (Hex)	Subindex	Content	Access	PDO Mapping	Value Range
1018	1	Identity object	Read Only	No	Unsigned 32

◆ Manufacturer Specific Profile Objects (DS 301)

The SI-S3/V option unit offers the manufacturer specific objects listed below. These objects are specific to Yaskawa products and therefore not available on other CANopen products.

The manufacturer-specific object list consists of objects that have predefined, non-changeable content and objects that are freely configurable. The content of freely configurable objects can be determined by linking these objects to drive parameters, monitors or MEMOBUS/Modbus registers (refer to [Selectable Object Content on page 29](#)).

Input objects are processed in a cycle of 2 ms. Output objects are, depending on the object, updated in a cycle of either 2 ms or 8 ms. The update cycle cannot be changed.

Some of the output objects support a Change of State filter that can be used to reduce the bus traffic when quickly-changing values such as the output current and motor speed are mapped to TxPDOs with Change of State (transmission type FE (Hex)) enabled. Refer to [Change of State Filter on page 31](#) and [Transmission Type FE \(Hex\) for Transmit PDOs on page 31](#) for details.

Note: Freely configurable object content and the object Change of State filter function are available in option unit software version 3102 and later.

■ 2000 (Hex) - Operation Command

This object is used to start and stop the drive, to control the multi-function digital input terminals, and to trigger and reset faults.

Index (Hex)	Subindex	Content	Access	PDO Mapping	Data Length
2000	0	Operation Command	Read / Write	Possible	2 byte

Bit No. (Hex)	Description	Function
0	Forward Run	1: Forward run, 0: Stop (Enabled when b1-02=3)
1	Reverse Run	1: Reverse run, 0: Stop (Enabled when b1-02=3)
2	Terminal S3 Function	Multi-Function Input: H1-03
3	Terminal S4 Function	Multi-Function Input: H1-04
4	Terminal S5 Function	Multi-Function Input: H1-05
5	Terminal S6 Function	Multi-Function Input: H1-06
6 <1>	Terminal S7 Function	Multi-Function Input: H1-07
7	Not used	
8	External Fault (EF0)	1: External Fault Input (EF0)
9	Fault Reset	1: Fault Reset
A to F	Not used	

<1> CIMR-VC □□□□□□ drives do not have terminal S7.

■ 2010 (Hex) - Speed Command

Sets the frequency reference. The unit of this value depends on the setting of the drive parameter o1-03.

Index (Hex)	Subindex	Content	Access	PDO Mapping	Data Length
2010	0	Speed command	Read / Write	Possible	2 byte

■ 2020 (Hex) - Torque Limit

This object sets the torque limit in units of 0.1%. It can be used in Open Loop Vector control only.

Index (Hex)	Subindex	Content	Access	PDO Mapping	Data Length
2020	0	Torque Limit	Read / Write	Possible	2 byte

■ 2030 (Hex) - Torque Compensation

This object sets the torque compensation in units of 0.1%. It can be used in Open Loop Vector control only.

Index (Hex)	Subindex	Content	Access	PDO Mapping	Data Length
2030	0	Torque Compensation	Read / Write	Possible	2 byte

■ 2040 (Hex) - MEMOBUS/Modbus Read Request

This object can be used to read out the content of drive MEMOBUS/Modbus registers. The address of the MEMOBUS/Modbus must be written in byte 3 and 4 of Subindex 1, bytes 1 and 2 have to be set to 0. After sending a MEMOBUS/Modbus Read Request to the drive, the MEMOBUS/Modbus register content can be read out from object 2140H.

For more details on MEMOBUS/Modbus address and data, refer to the MEMOBUS/Modbus Data Table in Appendix C of the technical manual for the drive.

Index (Hex)	Subindex	Content	Access	PDO Mapping	Data Length
2040	0	Number of entries	Read Only	Possible	1 byte
	1	MEMOBUS/Modbus read request	Read / Write		2 + 2 byte 0000H + MEMOBUS/Modbus Address

■ 2050 (Hex) - MEMOBUS/Modbus Write Request

Using this object, drive MEMOBUS/Modbus registers can be written. The data must be written in byte 1 and 2 of Subindex 1, and the MEMOBUS/Modbus address must be written in bytes 3 and 4. After sending a MEMOBUS/Modbus Write Request to the drive, the response can be read from object 2150H.

For more details on MEMOBUS/Modbus address and data, refer to the MEMOBUS/Modbus Data Table in Appendix C of the technical manual for the drive.

Index (Hex.)	Subindex	Content	Access	PDO Mapping	Data Length
2050	0	Number of entries	Read Only	Possible	1 byte
	1	MEMOBUS/Modbus Write request	Read / Write		2 + 2 byte MEMOBUS/Modbus Data + Address

■ 2060 (Hex) - MEMOBUS/Modbus Unlimited ENTER Command

Depending on the drive parameter H5-11 setting, an ENTER command must be used to activate drive parameters changed via MEMOBUS/Modbus Write Commands. The unlimited ENTER command activates parameters in the drive RAM only. If the drive power is cycled, parameter changes are lost. If more than one parameter has been changed, it is enough to send only one ENTER command after the last parameter change. Doing so will activate all changed parameters. This ENTER command can be used without limitations.

To execute this type of ENTER command, "save" (73H + 61H + 76H + 65H) must be written in object 2060H, subindex 0.

Index (Hex)	Subindex	Content	Access	PDO Mapping	Data Length
2060	0	Unlimited ENTER command	Read / Write	Possible	4 byte

■ 2070 (Hex) - MEMOBUS/Modbus Limited ENTER Command

Depending on the drive parameter H5-11 setting, an ENTER command must be used to activate drive parameters changed via MEMOBUS/Modbus Write Commands. The limited ENTER command activates parameters in the drive's RAM and saves them to the EEPROM. When power supply loss occurs or the power supply is cycled, the drive will operate using the saved parameters. If more than one parameter has been changed, it is enough to send only one ENTER command after the last parameter change. Doing so will activate all changed parameters. This type of ENTER command can be applied approximately 100,000 times, and should be used only when necessary.

To execute this type of ENTER command, "save" (73H + 61H + 76H + 65H) must be written in object 2070H, subindex 0.

Index (Hex)	Subindex	Content	Access	PDO Mapping	Data Length
2070	0	Limited enter command	Read / Write	Possible	4 byte

■ 2080 (Hex) to 3100 (Hex) - Freely Configurable Input Objects

The content of these objects can be freely selected by linking them to drive MEMOBUS/Modbus registers. Refer to [Selecting the Object Content on page 29](#) for details.

Index (Hex)	Subindex	Content	Default	Access	PDO Mapping	Data Length
2080 <1>	0	Number of entries	2	Read Only	No	1 byte
	1	Value	-	Read / Write	Possible	4 byte
	2	MEMOBUS/Modbus register address for content 1 and 2	FFFF (Hex) / FFFF (Hex)	Read / Write <2>	No	4 byte
2090 to 20C0, 3000, and 3100 <1>	0	Number of entries	2	Read Only	No	1 byte
	1	Value	-	Read / Write	Possible	2 byte
	2	MEMOBUS/Modbus register address for content	FFFF (Hex)	Read / Write <2>	No	2 byte

<1> Available in option unit software version 3102 and later.

<2> Read / Write access when SI-S3/V is in the Pre-Operational state and read-only access if the SI-S3/V is in the Operational state or if the drive is running.

■ 2100 (Hex) / 2101 (Hex) - Drive Status

These objects can be used to monitor the drive status. The value in object 2100 (Hex) is not filtered. For the value in object 2101 (Hex) a Change of State filter can be set up as explained in [Change of State Filter on page 31](#).

Index (Hex)	Subindex	Content	Default	Access	PDO Mapping	Data Length	Update Cycle
2100	0	Drive Status <2>	-	Read Only	Possible	2 byte	2 ms
2101 <1>	0	Number of entries	4	Read Only	No	1 byte	-
	1	Drive Status <2>	-	Read Only	Possible	2 byte	2 ms
	2	MEMOBUS/Modbus register address for content	00FC (Hex)	Read Only	No	2 byte	-
	3	Filter value	0	Read / Write <3>	No	2 byte	
	4	Value filter type	1 (Bitmask)	Read / Write <3>	No	2 byte	

<1> Available in option unit software version 3102 and later.

<2> For details of the drive status, refer to [Table 8](#).

<3> Read / Write access when SI-S3/V is in the Pre-Operational state, Read only access if the SI-S3/V is in the Operational state or if the drive is running.

Table 8 Drive Status

Bit No. (Hex)	Function	Description
0	During Run	1: During Run 0: During Stop
1	During Zero Speed	1: During Zero Speed
2	Reverse Running	1: During Reverse Running 0: During Forward Running
3	During Fault Reset Signal Input	1: During Fault Reset Signal Input
4	During Speed Agree	1: During Speed Agree
5	During Drive Ready	1: During Drive Ready 0: Not Ready
6	During Alarm	1: During Alarm
7	During Fault	1: During Fault
8	During Operation Error	1: During Operation Error
9	During Momentary Power Loss	1: During Momentary Power Loss 0: During Power Loss
A	NetCtrl Status	1: NetCtrl
B	Digital Output 1 Status (function set in drive parameter H2-01)	1: ON 0: OFF
C	Digital Output 2 Status (function set in drive parameter H2-02)	1: ON 0: OFF
D	Digital Output 3 Status (function set in drive parameter H2-03)	1: ON 0: OFF
E	Motor 2 Selected	1: Motor 2 Selected
F	Not used	

■ 2110 (Hex) / 2111 (Hex) - Output Frequency

These objects can be used to monitor the output frequency. The value in object 2110 (Hex) is not filtered. For the value in object 2111 (Hex) a Change of State filter can be set up as explained in [Change of State Filter on page 31](#). The units used for the monitor value are determined by drive parameter o1-03.

Index (Hex)	Subindex	Content	Default	Access	PDO Mapping	Data Length	Update Cycle
2110	0	Output Frequency	-	Read Only	Possible	2 byte	2 ms
2111 <1>	0	Number of entries	4	Read Only	No	1 byte	-
	1	Output Frequency	-	Read Only	Possible	2 byte	2 ms
	2	MEMOBUS/Modbus register address for content	0041 (Hex)	Read Only	No	2 byte	-
	3	Filter value	FFFF (Hex)	Read / Write <2>	No	2 byte	
	4	Value filter type	0 (Analog)	Read / Write <2>	No	2 byte	

<1> Available in option unit software version 3102 and later.

<2> Read / Write access when SI-S3/V is in the Pre-Operational state, Read only access if the SI-S3/V is in the Operational state or if the drive is running.

■ 2120 (Hex) / 2121 (Hex) - Output Current

These objects can be used to monitor the drive output current in amperes. The current value resolution is the same as in drive monitor U1-03 (For details, refer to the Technical Manual for the drive). The value in object 2120 (Hex) is not filtered. For the value in object 2121 (Hex), a Change of State filter can be set up as explained in [Change of State Filter on page 31](#).

Index (Hex)	Subindex	Content	Default	Access	PDO Mapping	Data Length	Update Cycle
2120	0	Output Current	-	Read Only	Possible	2 byte	8 ms
2121 <1>	0	Number of entries	4	Read Only	No	1 byte	-
	1	Output Current	-	Read Only	Possible	2 byte	8 ms
	2	MEMOBUS/Modbus register address for content	00FB (Hex)	Read Only	No	2 byte	-
	3	Filter value	FFFF (Hex)	Read / Write <2>	No	2 byte	
	4	Value filter type	0 (Analog)	Read / Write <2>	No	2 byte	

<1> Available in option unit software version 3102 and later.

<2> Read / Write access when SI-S3/V is in Pre-Operational state, Read only access if the SI-S3/V is in the Operational state or if the drive is running.

■ 2130 (Hex) / 2131 (Hex) - Output Torque Reference

These objects can be used to monitor the output torque reference. It can be used in Open Loop Vector control only. The value in object 2130 (Hex) is not filtered. For the value in object 2131 (Hex), a Change of State filter can be set up as explained in [Change of State Filter on page 31](#).

Index (Hex)	Subindex	Content	Default	Access	PDO Mapping	Data Length	Update Cycle
2130	0	Torque Reference	-	Read Only	Possible	2 byte	8 ms
2131 <1>	0	Number of entries	4	Read Only	No	1 byte	-
	1	Torque Reference	-	Read Only	Possible	2 byte	8 ms
	2	MEMOBUS/Modbus register address for content	0048 (Hex)	Read Only	No	2 byte	-
	3	Filter value	FFFF (Hex)	Read / Write <2>	No	2 byte	
	4	Value filter type	0 (Analog)	Read / Write <2>	No	2byte	

<1> Available in option unit software version 3102 and later.

<2> Read / Write access when SI-S3/V is in Pre-Operational state, Read only access if the SI-S3/V is in the Operational state or if the drive is running.

■ 2140 (Hex) - MEMOBUS/Modbus Read Response

This object contains the data of the drive MEMOBUS/Modbus register specified in object 2040 (Hex). Bytes 1 and 2 of subindex 1 will contain the data, and bytes 3 and 4 will contain the MEMOBUS/Modbus Address that was read.

Index (Hex)	Subindex	Content	Access	PDO Mapping	Data Length
2140	0	Number of entries	Read Only	Possible	1 byte
	1	MEMOBUS/Modbus read response			2 + 2 byte MEMOBUS/Modbus Data + Address

■ 2150 (Hex) - MEMOBUS/Modbus Write Response

This object contains the response from the drive when writing a drive parameter with a MEMOBUS/Modbus write command (object 2050 (Hex)). Bytes 1 and 2 of subindex 1 will contain the data that was written, and bytes 3 and 4 will contain the MEMOBUS/Modbus Address that was written to.

Index (Hex)	Subindex	Content	Access	PDO Mapping	Data Length
2150	0	Number of entries	Read Only	Possible	1 byte
	1	MEMOBUS/Modbus write response			2 + 2 byte MEMOBUS/Modbus Data + Address

■ 2155 (Hex) - PDO Parameter Write Response

Note: Available in option unit software version 3102 and later.

This object contains the response from the drive when writing a drive parameter directly using a RxPDO. Byte 1 contains the lower byte and byte 2 contains the higher byte of the message identifier (COB-ID) for the message that contains the parameter write request. Byte 3 contains the number of errors. This object can only be read if the SI-S3/V option is in the Operational state.

Refer to [Accessing Drive Parameters, Monitors and Control Registers Using PDOs on page 33](#) for details on writing parameters using PDOs.

Index (Hex)	Subindex	Content	Access	PDO Mapping	Data Length
2155	0	PDO Parameter Write Response (COB-ID of the RxPDO and number of errors)	Read Only	Possible	3 byte

■ 2160 (Hex) - MEMOBUS/Modbus Not Limited Enter Command Response

This object contains the response from the drive when writing an Enter command using object 2060 (Hex).

Index (Hex)	Subindex	Content	Access	PDO Mapping	Data Length
2160	0	MEMOBUS/Modbus not limited enter command response	Read Only	Possible	4 byte

■ **2180 (Hex) to 21F0 (Hex) - Freely Configurable Output Objects**

Note: These objects are available in option unit software version 3102 and later.

The content of these objects can be freely selected by linking them to drive MEMOBUS/Modbus registers. For 2 byte objects a Change of State filter can be applied. Refer to *Change of State Filter on page 31* for details.

Index (Hex)	Subindex	Content	Default	Access	PDO Mapping	Data Length	Update Cycle
2180	0	Number of entries	4	Read Only	No	1 byte	-
	1	Value	Input Terminal Status	Read Only	Possible	2 byte	8 ms
	2	MEMOBUS/Modbus register address for content	0049 (Hex)	Read / Write <1>	No	2 byte	-
	3	Filter value	0	Read / Write <1>	No	2 byte	
	4	Value filter type	1 (Bitmask)	Read / Write <1>	No	2 byte	
2190	0	Number of Entries	4	Read Only	No	1 byte	-
	1	Value	Analog Input A1 Monitor	Read Only	Possible	2 byte	8 ms
	2	MEMOBUS/Modbus register address for content	004E (Hex)	Read / Write <1>	No	2 byte	-
	3	Filter value	FFFF (Hex)	Read / Write <1>	No	2 byte	
	4	Value filter type	0 (Analog)	Read / Write <1>	No	2 byte	
21A0	0	Number of entries	4	Read Only	No	1 byte	-
	1	Value	-	Read Only	Possible	2 byte	8 ms
	2	MEMOBUS/Modbus register address for content	FFFF (Hex)	Read / Write <1>	No	2 byte	-
	3	Filter value	FFFF (Hex)	Read / Write <1>	No	2 byte	
	4	Value filter type	0 (Analog)	Read / Write <1>	No	2 byte	
21B0 to 21E0	0	Number of entries	4	Read Only	No	1 byte	-
	1	Value	-	Read Only	Possible	2 byte	2 ms
	2	MEMOBUS/Modbus register address for content	FFFF (Hex)	Read / Write <1>	No	2 byte	-
	3	Filter value	FFFF (Hex)	Read / Write <1>	No	2 byte	
	4	Value filter type	0 (Analog)	Read / Write <1>	No	2 byte	
21F0	0	Number of entries	2	Read Only	No	1 byte	-
	1	Value	-	Read Only	Possible	4 byte	8 ms
	2	MEMOBUS/Modbus register address for content 1 and 2	FFFF (Hex) / FFFF (Hex)	Read / Write <1>	No	4 byte	-

<1> Read / Write access when SI-S3/V is in the Pre-Operational state, Read only access if the SI-S3/V is in the Operational state or if the drive is running.

■ **2200 (Hex) / 2201 (Hex) - Motor Speed**

These objects can be used to monitor the motor speed. The unit of this value depends on the setting of drive parameter o1-03. The register content is zero if the drive is set for V/f control. The value in object 2200 (Hex) is not filtered. For the value in object 2201 (Hex), a Change of State filter can be set up as explained in *Change of State Filter on page 31*.

Index (Hex)	Subindex	Content	Default	Access	PDO Mapping	Data Length	Update Cycle
2200	0	Motor Speed	-	Read Only	Possible	2 byte	2 ms
2201 <1>	0	Number of Entries	4	Read Only	No	1 byte	-
	1	Motor Speed	-	Read Only	Possible	2 byte	2 ms
	2	MEMOBUS/Modbus register address for content	0044 (Hex)	Read Only	No	2 byte	-
	3	Filter value	FFFF (Hex)	Read / Write <2>	No	2 byte	
	4	Value filter type	0 (Analog)	Read / Write <2>	No	2 byte	

<1> Available in option unit software version 3102 and later.

<2> Read / Write access when SI-S3/V is in the Pre-Operational state, Read only access if the SI-S3/V is in the Operational state or if the drive is running.

◆ **Drives and Motion Profile Objects (DSP 402)**

The drive supports Drive and Motion Profile DSP 402 Velocity Mode. Before using Velocity Mode, objects for following parameters must be set up in the drive:

- The number of motor poles must be set to E2-04.
- The frequency reference and output frequency display unit must be set to r/min by setting parameter o1-03 = 2.

If these settings are incorrect, the Velocity Mode objects may be unusable, or the drive might not operate as expected.

■ **6040 (Hex) - Controlword**

This object sets the device to different states.

Index (Hex)	Subindex	Content	Access	PDO Mapping	Value Range
6040	0	Controlword	Read / Write	Possible	0...65535

■ **6041 (Hex) - Statusword**

This object shows different states of the device.

Index (Hex)	Subindex	Content	Access	PDO Mapping	Value Range
6041	0	Statusword	Read Only	Possible	0...65535

■ 6042 (Hex) - vl Target Velocity

This object sets the speed reference and the run command. It is internally multiplied with the vl dimension factor (604C). Can be set when the status in Controlword 6040 (Hex) is "Operation Enable".

Index (Hex)	Subindex	Content	Access	PDO Mapping	Value Range	Unit
6042	0	vl target velocity	Read / Write	Possible	-32768...0...32767	r/min

■ 6043 (Hex) - vl Velocity Demand

The vl velocity effort is the output frequency of the drive to the motor.

Index (Hex)	Subindex	Content	Access	PDO Mapping	Value Range	Unit
6043	0	vl velocity demand	Read Only	Possible	-32768...0...32767	r/min

■ 6044 (Hex) - vl Control Effort

The vl control effort is the motor speed.

Index (Hex)	Subindex	Content	Access	PDO Mapping	Value Range	Unit
6044	0	vl control effort	Read Only	Possible	-32768...0...32767	r/min

■ 6046 (Hex) - vl Velocity Min Max Amount

This object provides two subindexes to set the minimum and maximum speed reference in r/min.

Index (Hex)	Subindex	Content	Access	PDO Mapping	Value Range	Unit
6046	1	vl velocity min amount	Read / Write	Possible	0...(2 ³² -1)	r/min
	2	vl velocity max amount				

■ 6048 (Hex) - vl Velocity Acceleration

The vl velocity acceleration specifies the acceleration time. The quotient of the subindexes delta speed and delta time determines the acceleration time. The object values correspond to the acceleration time setting in the drive.

Index (Hex)	Subindex	Content	Access	PDO Mapping	Value Range	Unit
6048	1	Delta speed	Read / Write	Possible	0...(2 ²³ -1)	r/min
	2	Delta time			0...65535	sec

■ 6049 (Hex) - vl Velocity Deceleration

The vl velocity min max amount specifies the deceleration time. The quotient of the subindexes delta speed and delta time determines the deceleration time. The object values correspond to the deceleration time setting in the drive.

Index (Hex)	Subindex	Content	Access	PDO Mapping	Value Range	Unit
6049	1	Delta speed	Read / Write	Possible	0...(2 ²³ -1)	r/min
	2	Delta time			0...65535	sec

■ 604A (Hex) - vl Velocity Quick Stop

The vl velocity quick stop specifies the quick stop ramp. The quotient of the subindexes delta speed and delta time determines the quick stop ramp time. The object values correspond to the fast stop time setting in the drive.

Index (Hex)	Subindex	Content	Access	PDO Mapping	Value Range	Unit
604A	1	Delta speed	Read / Write	Possible	0...(2 ²³ -1)	r/min
	2	Delta time			0...65535	sec

■ 604C (Hex) - vl Dimension Factor

The vl dimension factor is multiplied with the target velocity. The quotient of the subindexes vl dimension factor numerator and vl dimension factor denominator determines the vl dimension factor.

Index (Hex)	Subindex	Content	Access	PDO Mapping	Value Range
604C	1	vl dimension factor numerator	Read / Write	Possible	-2 ³¹ ...(2 ³¹ -1)
	2	vl dimension factor denominator			

■ 604D (Hex) - vl Pole Number

The vl pole number sets the number of motor poles and is used to calculate all speed related values in r/min. This value corresponds to the number of motor poles setting in the drive.

Index (Hex)	Subindex	Content	Access	PDO Mapping	Value Range
604D	0	vl pole number	Read / Write	No	0...255

■ 6061 (Hex) - Modes of Operation Display

This object shows the mode of the device. The object supports 2 (Velocity Mode) only.

Index (Hex)	Subindex	Content	Access	PDO Mapping	Value Range
6061	0	Modes of operation display	Read Only	Possible	-128...127

■ 60FD (Hex) - Digital Inputs

This object contains the drive digital output status (seen as input to the network).

The content of this object is equal to drive MEMOBUS/Modbus register 004A (Hex) (drive output terminal status monitor U1-11), and depends on the drive the SI-S3/V option unit is used with. For details of the contents of this register refer to the technical manual for the drive.

Index (Hex)	Subindex	Content	Access	PDO Mapping	Value Range
60FD	0	Drive digital input status	Read Only	Possible	0...(2 ³² -1)

Bit No. (Hex)	Function	Description
0 to F	Not used	
10 to 1F	Bit 0 to F of drive register 004A (Hex) (drive output terminal status monitor U1-11)	1: ON 0: OFF

■ 60FE (Hex) - Digital Outputs

This object is used to set drive digital inputs (seen as output from the network).

Index (Hex)	Subindex	Content	Access	PDO Mapping	Value Range
60FE	1	Drive Digital Input Command	Read / Write	Possible	0...(2 ³² -1)

Bit No. (Hex)	Function	Description
0 to 11	Not used	
12	Terminal S3 Function	Multi-Function Input: H1-03
13	Terminal S4 Function	Multi-Function Input: H1-04
14	Terminal S5 Function	Multi-Function Input: H1-05
15	Terminal S6 Function	Multi-Function Input: H1-06
16 <1>	Terminal S7 Function	Multi-Function Input: H1-07
17	Not used	
18	External Fault (EF0)	1: External Fault Input (EF0)
19	Fault Reset	1: Fault Reset
1A to 1F	Not used	

<1> CIMR-VC □□□□□□ drives do not have terminal S7.

9 Configuring Manufacturer Specific Objects

This section describes the configuration of manufacturer specific objects that support content selection and Change of State filtering.

Note: The functions described in this section are available in option unit software 3102 and later.

◆ Selectable Object Content

All parameters, monitors and other control registers in the drive are represented by their MEMOBUS/Modbus register. Using the addresses of these registers, the content of some manufacturer-specific objects can be selected. Refer to the drive Technical Manual for details on available MEMOBUS/Modbus registers.

■ Selecting the Object Content

Objects with selectable content have the following structure:

Object Type	Subindex	Content	Access	PDO Mapping	Data Length
2 Byte	0	Number of entries	Read Only	No	1 byte
	1	Data	depends on object	Possible	2 byte
	2	MEMOBUS/Modbus register address of content	Read / Write <I>	No	2 byte
4 Byte	0	Number of entries	Read Only	No	1 byte
	1	Data	depends on object	Possible	4 byte
	2	MEMOBUS/Modbus register address of content 1 and 2	Read / Write <I>	No	4 byte

<I> Read / Write access when SI-S3/V is in the Pre-Operational state, Read only access if the SI-S3/V is in the Operational state or if the drive is running.

To map the content of a specific MEMOBUS/Modbus register of the drive to subindex 1 of an object, the MEMOBUS/Modbus register address must be written to subindex 2 of the object.

Examples

- In order to map the drive output power monitor (U1-08, 0047 (Hex)) to output object 21A0 (Hex), write 0047 (Hex) to subindex 2 of object 21A0 (Hex).
- In order to map the speed reference 1 (d1-01, 0280 (Hex)) to input object 2090 (Hex), write 0280 (Hex) to subindex 2 of object 2090 (Hex).
- In order to map the input terminal status (U1-10, 0049 (Hex)) and output terminal status (U1-11, 004A (Hex)) to output object 21F0 (Hex) (4 byte), write 0049 (Hex) to the higher word and 004A (Hex) to the lower word of object 2090 (Hex), subindex 2.

■ Limitations Affecting Object Content Selection

The following limitations must be considered when setting the content of an object.

- The object content can only be changed when the SI-S3/V option unit is in the Pre-Operational state and the drive is stopped (Run command not active).
- The SI-S3/V cannot be switched to the Operational state until the content selection process is complete. Otherwise, an emergency message (code 6301 (Hex)) will be sent.
- While object content selection is ongoing, no other request or command, including Run, should be sent to the drive. Otherwise, an error message or emergency message (code 6301 (Hex)) will be sent.
- If the object content mapping is changed from the default setting and a Reset Node command is issued while Run is active, the drive will first be stopped and then will be reset.
- For 4 byte input objects 2080 (Hex), MEMOBUS/Modbus register numbers below 0100 (Hex) can be linked in any combination. If MEMOBUS/Modbus register numbers equal to or greater than 0100 (Hex) are linked to a 4 byte object 2080 (Hex), the MEMOBUS/Modbus register numbers must be consecutive.

Mapped Register 1	Mapped Register 2	
0007 (Hex)	0009 (Hex)	Possible
0201 (Hex)	0202 (Hex)	Possible
0202 (Hex)	0201 (Hex)	Not possible
0201 (Hex)	0203 (Hex)	Not possible
0202 (Hex)	0202 (Hex)	Not possible
0200 (Hex)	FFFF (Hex)	Possible
FFFF (Hex)	0200 (Hex)	Possible

- Register numbers can be non-consecutive for 4 byte output objects 21F0 (Hex).
- A MEMOBUS/Modbus register cannot be mapped to two or more objects at the same time.
- MEMOBUS/Modbus registers 0001 (Hex), 0002 (Hex), 0004 (Hex), 0005 (Hex), and 0014 (Hex) cannot be linked to any object with selectable content. Any attempt to map one of those registers to such an input object will result in an error message.

10 Process Data Objects (PDO)

◆ PDOs and Default PDO Setup

The drive supports 15 Receive and 16 Transmit PDOs. The tables below show the available PDOs, their default settings, and the objects that need to be set when changing the PDO configuration or the PDO mapping:

■ Receive PDOs (RxPDO)

PDO number	Receive PDO Parameter		Receive PDO Mapping	
	COB-ID (Hex)	Index (Hex)	Mapped objects (Hex)	Index (Hex)
1	200 + Node ID	1400	Subindex 1: 6040	1600
2	300 + Node ID	1401	Subindex 1: 6040 Subindex 2: 6060	1601
6	Not assigned	1405	Subindex 1: 6040 Subindex 2: 6042	1605
7	Not assigned	1406	Subindex 1: 6040 Subindex 2: 60FE sub1	1606
8	Not assigned	1407	Subindex 1: 6040 Subindex 2: 6060	1607
21	Not assigned	1414	Subindex 1: 6048 sub1 Subindex 2: 6048 sub2	1614
22	Not assigned	1415	Subindex 1: 6049 sub1 Subindex 2: 6049 sub2	1615
23	Not assigned	1416	Subindex 1: 604A sub1 Subindex 2: 604A sub2	1616
24	Not assigned	1417	Subindex 1: 604C sub1 Subindex 2: 604C sub2	1617
36	Not assigned	1423	Subindex 1: 2000	1623
37	Not assigned	1424	Subindex 1: 2010	1624
38	Not assigned	1425	Subindex 1: 2020	1625
39	Not assigned	1426	Subindex 1: 2030	1626
40	Not assigned	1427	Subindex 1: 2040 sub1	1627
41	Not assigned	1428	Subindex 1: 2050 sub1	1628

■ Transmit PDO (TxPDO)

PDO number	Transmit PDO Parameter		Transmit PDO Mapping	
	COB-ID (Hex)	Index (Hex)	Mapped objects (Hex)	Index (Hex)
1	180 + Node ID	1800	Subindex 1: 6041	1A00
2	280 + Node ID	1801	Subindex 1: 6041 Subindex 2: 6061	1A01
6	Not assigned	1805	Subindex 1: 6041 Subindex 2: 6044	1A05
7	Not assigned	1806	Subindex 1: 6041 Subindex 2: 60FD	1A06
21	Not assigned	1814	Subindex 1: 6042	1A14
22	Not assigned	1815	Subindex 1: 6043	1A15
23	Not assigned	1816	Subindex 1: 6048 sub1 Subindex 2: 6048 sub2	1A16
24	Not assigned	1817	Subindex 1: 6049 sub1 Subindex 2: 6049 sub2	1A17
25	Not assigned	1818	Subindex 1: 604A sub1 Subindex 2: 604A sub2	1A18
26	Not assigned	1819	Subindex 1: 604C sub1 Subindex 2: 604C sub2	1A19
36	Not assigned	1823	Subindex 1: 2100	1A23
37	Not assigned	1824	Subindex 1: 2110	1A24
38	Not assigned	1825	Subindex 1: 2120	1A25
39	Not assigned	1826	Subindex 1: 2130	1A26
40	Not assigned	1827	Subindex 1: 2140 sub1	1A27
41	Not assigned	1828	Subindex 1: 2150 sub1	1A28

◆ Receive PDO Configuration and Mapping

A receive PDO can be configured using the corresponding 14□□ (Hex) object, and the mapping can be changed in the 16□□ (Hex) object that belongs to the PDO.

■ PDO Configuration

Index (Hex)	Subindex	Content	Default	Access	Data Length
14□□	0	Largest subindex supported	2	Read Only	1 byte
	1	COB-ID used by the RxPDO	see Receive PDO table above	Read/Write	4 byte
	2	Transmission type	FE	Read/Write	1 byte

■ PDO Mapping

Index (Hex)	Subindex (Hex)	Content	Default	Access	Data Length
16□□	0	Number of mapped RxPDO's	see Receive PDO table above	Read/Write	1 byte
	1 to 40	Data length, subindex and index of the object to be mapped	see Receive PDO table above	Read/Write	4 byte

Note: When changing the PDO mapping, always first set subindex 0 to "0", then set subindex 1 to subindex n. Then activate the mapping by setting subindex 0 to the number of mapped objects n.

◆ Transmit PDO Configuration and Mapping

A transmit PDO can be configured by using the corresponding 18□□ (Hex) object, and the mapping can be changed in the 1A□□ (Hex) object that belongs to the PDO.

■ PDO Configuration

Index (Hex)	Subindex	Content	Default	Access	Data Length
18□□	0	Largest subindex supported	5	Read Only	1 byte
	1	COB-ID used by the TxPDO	see TxPDO table above	Read/Write	4 byte
	2	Transmission type	depends on PDO	Read/Write	1 byte
	3	Inhibit time (Set as a multiple of 100 us)	0	Read/Write	2 byte
	5	Event timer (Set as a multiple of 1 ms)	0	Read/Write	2 byte

■ PDO Mapping

Index (Hex)	Subindex (Hex)	Content	Default	Access	Data Length
1A□□	0	Number of mapped PDOs	see transmit PDO table above	Read Only	1 byte
	1 to 40	Data length, subindex and index of the object to be mapped	see transmit PDO table above	Read/Write	4 byte

Note: When changing the PDO mapping, always first set subindex 0 to "0", then set subindex 1 to subindex n. Then activate the mapping by setting subindex 0 to the number of mapped objects n.

■ Transmission Type FE (Hex) for Transmit PDOs

When the transmission type of a TxPDO is set to FE (Hex), the PDO is automatically transmitted whenever the value in one of the mapped objects changes.

When this transmission type is used for a TxPDO that is mapped to an object with a Change of State filter, the filter can be used to reduce the amount of data transferred if the object value changes quickly (refer to [Change of State Filter on page 31](#)). The filter must be set to a value that is different from FFFF (Hex). If a large filter value is applied, then it can be helpful to also set an event timer for the PDO (18□□ (Hex), subindex 5). In this way, the PDO is triggered cyclically even if the change in the value of the linked object does not exceed the filter value. In this way, variations within the filter can still be seen without having a large number of messages sent.

Note: When a Change of State filter and an event timer are used simultaneously, the PDO will be triggered by whichever one is received first, the timer event or the Change of State event. If the PDO is triggered by the Change of State event, the event timer will be reset.

■ Change of State Filter

Note: This function is available in option unit software 3102 and later.

Some Output objects of the Manufacturer Specific Profile support a Change of State filter. If such an object is mapped to a TxPDOs with transmission type FE (Change of State), and the filter is set up, a Change of State event is triggered (i.e., the PDO is transmitted) only if the change in the object value exceeds the filter value. Such objects have the following structure and can be set up as explained below.

Index (Hex)	Subindex	Content	Access	PDO Mapping	Data Length
2101, 2111, 2121, 2131, 2180 to 21E0, 2201	0	Number of entries	Read Only	No	1 byte
	1	Object value	Read Only	Possible	2 byte
	2	MEMOBUS/Modbus register address for content	Read / Write <>	No	2 byte
	3	Filter value	Read / Write <>	No	2 byte
	4	Filter type	Read / Write <>	No	2 byte

<> Read / Write access when SI-S3/V is in the Pre-Operational state, Read only access if the SI-S3/V is in the Operational state or if the drive is running.

Subindex 0: Number of Entries

Contains the number of subindices.

Subindex 1: Object Value

This subindex contains the value of the object (value of the MEMOBUS/Modbus register specified in the subindex 2).

10 Process Data Objects (PDO)

Subindex 2: MEMOBUS/Modbus Address of Content

This subindex contains the address of the drive MEMOBUS/Modbus register that the object is linked to. Setting FFFF (Hex) to subindex 2 will disable the object (i.e., the value in subindex 1 will be 0).

Subindex 3: Filter Value

Sets the filter value for the Change of State event if the object is mapped to a TxPDO with transmission type FE (Hex).

When the filter value is set to 0000 (Hex), the Change of State event will be triggered whenever the value of the MEMOBUS/Modbus register specified in subindex 2 changes. When the filter is set to FFFF (Hex), the Change of State event will not be triggered.

Subindex 4: Filter Type

This subindex is used to select the filter type. Two filter types are available, an analog filter and a bitmask filter.

If the analog filter is selected (subindex 4 = 0), the value of the MEMOBUS/Modbus register specified in subindex 2 must change by the amount set in subindex 3 before a Change of State event is triggered. The filter has no unit. The resolution depends on the value of the MEMOBUS/Modbus register content.

If the bitmask filter is selected (subindex 4 = 1), the Change of State event will be triggered whenever the value of the MEMOBUS/Modbus register specified in subindex 2 changes in any bit except the masked bits. If a bitmask is set, the TxPDO will be triggered only if bits that are set to “0” in the mask change. Bits set to “1” are ignored.

Examples

Object Content (Subindex 2)	Filter Value (Subindex 3)	Filter Type (Subindex 4)	Resolution of Object Value	Object Value Behavior
Output frequency (0041 Hex)	A (Hex)	0 (Analog)	0.01 Hz	Change of State is triggered when the output frequency changes by more than 0.10 Hz.
Output voltage (0054 Hex)	32 (Hex)	0 (Analog)	0.1 V	Change of State is triggered when the output voltage changes by more than 5.0 V.
Drive Status (0020 Hex)	0	1 (Bitmask)	-	Change of State is triggered when any bit in the drive status word changes.
Drive Status (0020 Hex)	03 (Hex) 0000 0000 0000 0011 (Bin)	1 (Bitmask)	-	Change of State is triggered by any status change except “During Run” (bit 0) and “During Zero Speed” (bit 1).
Drive Status (0020 Hex)	09 (Hex) 0000 0000 0000 1001 (Bin)	1 (Bitmask)	-	Change of State is triggered by any status change except “During Run” (bit 0) and “During Fault Reset Input” (bit 3).

11 Drive Parameter, Monitor and Control Register Access

All drive parameters, monitors, and other control registers are represented by their MEMOBUS/Modbus register. They can be read or written by accessing these registers through the SI-S3/V option unit.

MEMOBUS/Modbus registers can be directly read or written by using the MEMOBUS/Modbus read/write commands. They can also be mapped to the content of a manufacturer-specific object, and then be accessed by reading from or writing to this object. Refer to [Selecting the Object Content on page 29](#) for details on object content selection.

When writing drive parameters, some general precautions concerning the message timing have to be taken into account.

- The drive needs some time to activate changes to parameter values. When changing multiple parameters, be sure to add a wait time between write requests.
- If an Enter command is issued, be sure to add a wait time between the Enter command and the next message.

Refer to the drive technical manual for more information about MEMOBUS/Modbus addresses available in the drive and the wait times required between parameter write requests and Enter commands.

◆ Drive Parameter and Monitor Access by MEMOBUS/Modbus Read/Write Commands

■ Reading a Drive Register, Parameter or Monitor

Reading a drive parameter, monitor or control register using a MEMOBUS/Modbus read command requires the following steps:

- Write the address of the drive MEMOBUS/Modbus register to be read to subindex 0 of object 2040 (Hex).
- Read the value of the drive MEMOBUS/Modbus register from the MEMOBUS/Modbus read response in subindex 1 of object 2140 (Hex).

Objects 2040 (Hex) and 2140 (Hex) can both be mapped to PDOs.

■ Writing to a Parameter or Drive Control Register

Writing to drive parameters or control registers can be performed by following the steps below:

- Write the value and the MEMOBUS/Modbus address of the drive parameter or control register to subindex 1 of object 2050 (Hex).
- Read the MEMOBUS/Modbus write response from subindex 1 of object 2150 (Hex) to verify that the item was written correctly.

If drive parameters are written and parameter H5-11 in the drive is set to 0, a RAM Enter command (object 2060 (hex)) must additionally be issued in order to allow the change take effect. To store the parameter change in the non-volatile memory of the drive, a ROM Enter command (object 2070 (hex)) must be issued instead. An Enter command can be issued by performing the steps below.

- Write "save" (73H + 61H + 76H + 65H) to subindex 1 of object 2060 (Hex) for a RAM Enter command, or to subindex 1 of object 2070 (Hex) for a ROM Enter command.
- When using a RAM Enter command, read the Enter command response from object 2160 (hex) to verify whether the Enter command was successful.

Note: When multiple drive parameters are changed, only one Enter command is required after the last parameter value to activate all parameter changes.

Objects 2050/01 (Hex), 2060 (Hex), 2070 (Hex), 2150/01 (Hex) and 2160 (Hex) can be mapped to PDOs.

◆ Accessing Drive Parameters and Monitors that are Mapped to Objects

Note: The functions described in this section are available in option unit software 3102 and later.

When drive items like parameters, monitors, or control registers are mapped to manufacturer-specific objects, they can also be read or written directly by using SDO or PDO messages instead of MEMOBUS/Modbus read/write commands.

■ Accessing Drive Parameters, Monitors and Control Registers Using SDOs

A drive parameter, monitor or control register can be accessed by using a normal SDO read or write message on the object it is mapped to. The SDO response will contain the write request answer or error information (e.g., if parameter limits were exceeded, if a read/write access violation occurred, etc.).

Note: If drive parameter H5-11 is set to 0, an Enter command must be issued to allow the parameter change become active in the drive. When multiple drive parameters are changed, only one Enter command is required after the last parameter value to activate all parameter changes.

■ Accessing Drive Parameters, Monitors and Control Registers Using PDOs

When a drive parameter, monitor, or control register is connected to an object and the object is mapped to a PDO, the connected drive item can be accessed directly by using this PDO.

Reading Drive Parameters, Monitors, or Control Registers

In order to read a drive item directly by using a PDO, the object that contains the item must be mapped to a TxPDO. The TxPDO can either be triggered on remote request (RTR) or can be configured to be sent automatically by timer or upon Change of State events.

Example: To read the output power monitor U1-08 via the PDO, the monitor must be mapped to an output object, e.g., 21A0 (Hex). This object must then be mapped to a PDO, e.g., TxPDO 6.

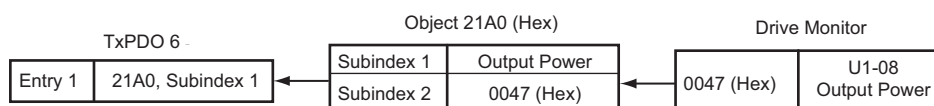

11 Drive Parameter, Monitor and Control Register Access

Writing Parameters

In order to write a drive parameter directly by using a PDO, the object that contains the drive parameter must be mapped to an RxPDO. Writing data using this RxPDO will change the data in the drive immediately without the need for an Enter command. To store the parameter change in the non-volatile memory of the drive, a ROM Enter command must be issued after the last parameter change.

Up to four objects that are connected to drive parameters can be mapped to one PDO. In the example below, RxPDO 6 is used to write drive parameters C1-01, C1-02, C1-09 and d1-01 simultaneously.

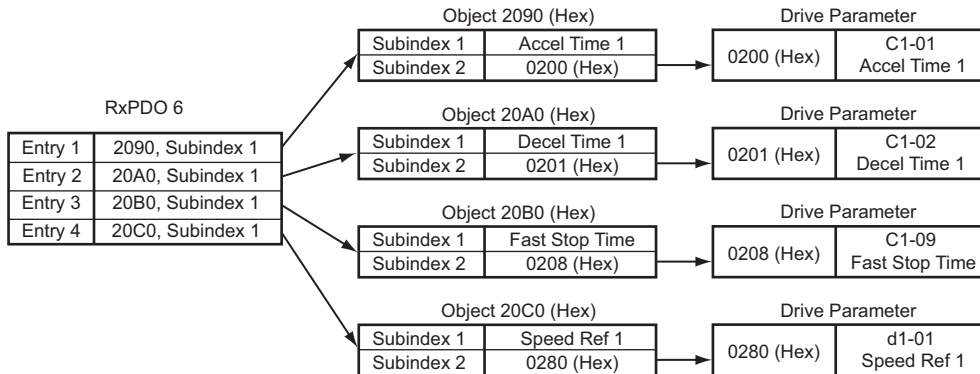

If the PDO contains invalid data, then only the valid data will be written to the drive. Using the example above, if the data for C1-01, C1-09 and d1-01 are valid and the data for C1-02 is out of range, then only parameters C1-01, C1-09 and d1-01 will be changed in the drive, and the data for C1-02 will be ignored.

Write Response

The PDO write response object allows the user to recognize errors that occur when writing parameters as in the example above. The drive stores the COB-ID of the parameter writing PDO and the number of invalid registers in object 2155 (Hex), subindex 0. The data configuration of object 2155 (Hex) is shown in the table below.

Index (Hex)	Subindex	Byte	Content
2155	0	0	Lower byte of the COB-ID of the parameter write RxPDO
		1	Higher byte of the COB-ID of the parameter write RxPDO
		2	Number of invalid registers

When writing parameters directly by using PDOs, object 2155 (Hex) should always be used in order to confirm that the data has been written correctly. Object 2155 (Hex) should be mapped to a TxPDO with transmission type FE (Hex) (Change of State), so that each parameter writing PDO is answered automatically and write errors can be easily detected.

- Note:**
- Object 2155 (Hex) will only be refreshed when the SI-S3/V receives parameter write requests via PDOs, or if an object of the Drive Profile that is linked to a drive parameter (e.g. 6048 (Hex)) is changed using a PDO. It will not be refreshed when parameters are changed using SDOs.
 - Reading of this object using an SDO will cause an error response message if no parameter write PDO has been sent previously.

◆ Initializing the Drive

The drive can be initialized by writing the corresponding initialization code to Modbus/MEMOBUS register 0103 (hex) (drive parameter A1-03; refer to the Technical Manual of the drive for details on initialization codes). The initialization is performed only if drive parameter H5-11 is set to "0" and if an Unlimited Enter Command is sent after setting register 0103 (hex).

To initialize a drive via CANopen communications, follow the instructions below:

- Read out the value of drive parameter H5-11 using a Modbus/MEMOBUS Read Request (Obj. 2040 (hex)) on drive register 04C3 (hex) (H5-11).
- If the content of register 04C3 (hex) is "1" then change it to "0" using a Modbus/MEMOBUS Write Request (Obj. 2050 (hex)).
- Set drive parameter A1-03 to the desired initialization mode. For example, in order to perform a "2-Wire Initialization", write "08AC" (hex) (2220) to Modbus/MEMOBUS register 0103 (hex).
- Finish the initialization by sending an Unlimited Enter Command (Obj. 2060 (hex)).

12 Fault Diagnosis and Possible Solutions

◆ CANopen Option Unit Error Codes

Refer to [Table 7](#) for a list of possible error codes.

◆ Drive-Side Error Codes

Drive-side error codes appear on the drive's LED operator. Causes of the errors and corrective actions are listed in [Table 9](#) and [Table 10](#). For additional error codes that may appear on the LED operator screen, refer to the technical manual for the drive.

bUS (CANopen Option Communication Error) and EF0 (External Fault Input from the CANopen Option) may appear as an alarm or a fault. When a fault occurs, the digital operator LEDs will remain lit. When an alarm occurs, the digital operator LEDs will flash and the "ALM" light will illuminate.

If communication stops while the drive is running, check the following items:

- Is the CANopen Option properly installed?
- Is the communication line properly connected to the CANopen Option? Is it loose?
- Is the controller program working? Has the controller CPU stopped?
- Did a momentary power loss interrupt communications?

■ Faults

[Table 9](#) lists possible faults when using a communication option board. The drive's fault contact will close if one of these faults occurs.

Table 9 Fault Display and Possible Solutions

LED Operator Display		Fault Name
bUS	bUS	CANopen Option Communication Error
		After establishing initial communication, the connection was lost. Only detected when the run command or frequency reference is assigned to the option (b1-01=3 or b1-02=3).
Cause		Possible Solution
Master controller (PLC) has stopped communicating.		Check for faulty wiring.
Communication cable is not connected properly.		⇒ Correct any wiring problems.
A data error occurred due to noise.		Check the various options available to minimize the effects of noise. ⇒ Take steps to counteract noise in the control circuit wiring, main circuit lines, and ground wiring. ⇒ If a magnetic contactor is identified as a source of noise, install a surge absorber to the contactor coil. ⇒ Make sure the cable used fulfills the CANopen requirements. Ground the shield on the controller side and on the CANopen Option side.
CANopen Option is damaged.		⇒ If there are no problems with the wiring and the error continues to occur, replace the CANopen Option.

LED Operator Display		Fault Name
EF0	EF0	External Fault Input from CANopen Option
		The alarm function for an external device has been triggered.
Cause		Possible Solution
An external fault is being sent from the upper controller (PLC).		⇒ Remove the cause of the external fault. ⇒ Reset the external fault input from the upper controller (PLC) device.
Problem with the upper controller (PLC) program.		⇒ Check the program used by the upper controller (PLC) and make the appropriate corrections.

LED Operator Display		Fault Name
oFA00	oFA00	CANopen Option Fault
		CANopen Option is not properly connected.
Cause		Possible Solution
Non-compatible option connected to the drive.		⇒ Connect an option that is compatible with the drive.

LED Operator Display		Fault Name
oFA01	oFA01	CANopen Option Fault
		CANopen Option is not properly connected.
Cause		Possible Solution
Problem with the connectors between the drive and CANopen Option.		⇒ Turn the power off and check the connectors between the drive and CANopen Option.

LED Operator Display		Fault Name
oFA03	oFA03	CANopen Option Fault
		CANopen Option self-diagnostics error.
Cause		Possible Solution
CANopen Option hardware fault.		⇒ Replace the CANopen Option. Contact Yaskawa for assistance.

12 Fault Diagnosis and Possible Solutions

LED Operator Display		Fault Name
oFA04	oFA04	CANopen Option Fault
		CANopen Option Flash write mode
Cause		Possible Solution
CANopen Option hardware fault.		⇒ Replace the CANopen Option. Contact Yaskawa for assistance.

LED Operator Display		Fault Name
oFA30 to oFA43	oFA30 to oFA43	CANopen Option Fault (port A)
		Communication ID error
Cause		Possible Solution
CANopen Option hardware fault		⇒ Replace the CANopen Option. Contact Yaskawa for assistance.

LED Operator Display		Fault Name
PE1	PE1	Programming Error 1
		Object content mapping was changed from the default, and Node Reset was sent while the drive was running.
Cause		Possible Solution
The object dictionary settings were different from the settings stored in the EEPROM of the SI-S3/V, and Node Reset (NMT 81h xxh) was performed while the drive was running.		⇒ Stop the drive before performing Node Reset. ⇒ Save the object dictionary settings using Store Parameters (object 1010 (hex)) before performing Node Reset.

■ Minor Faults and Alarms

Table 10 lists up alarms that might occur during operation using a communication option board. If a multi function digital output of the drive is programmed for H2-□□ = 10, the output will close if these alarms occur.

Table 10 Alarm Codes and Possible Solutions

LED Operator Display		Minor Fault Name	
AEr	AEr	Setting Address Error	
		CANopen Option is set to an address outside the allowable setting range.	
Cause		Possible Solution	Minor Fault (H2-□□ = 10)
Address outside the specified address range		⇒ Set F6-35 to an address within the specified range.	YES

LED Operator Display		Minor Fault Name	
CALL	CALL	Serial Communication Transmission Error	
		Communication has not yet been established.	
Cause		Possible Solution	Minor Fault (H2-□□ = 10)
Communication wiring is faulty, there is a short circuit, or something is not connected properly.		Check for wiring errors. ⇒ Correct the wiring. ⇒ Remove and ground shorts and reconnect loose wires.	YES
Programming error on the master side		⇒ Check communications at start-up and correct programming errors.	
Communication circuitry is damaged.		⇒ Replace the drive if the fault continues to occur.	

◆ SDO Abort Codes

SDO abort codes are supported as specified in DS301. Additionally, the abort codes listed below are also implemented.

SDO Abort Code	Description
0602 0010 (Hex)	Consecutive MEMOBUS/Modbus Read/Write/Enter commands are being sent but the wait time between messages is too short.
	A MEMOBUS/Modbus Read or Write Response (2140 (Hex) and 2150 (Hex)) was received, but either an incorrect MEMOBUS/Modbus address or no MEMOBUS/Modbus address has been written to object 2040 (Hex) or 2050 (Hex) before.
	A MEMOBUS/Modbus write request was sent while DC bus was under voltage.
0602 0022 (Hex)	Drive Profile DSP402 was used and a value was written to object 6042 (Hex) (v1 Target Velocity) while the drive status was not "Operation Enable".
	Object 2155 (Hex) was received while the SI-S3/V option was not in the Operational state.
	A MEMOBUS/Modbus Read or Write command (2040 (Hex) and 2050 (Hex)) was performed with an invalid MEMOBUS/Modbus address.

13 Specifications

◆ Specifications

Table 11 Option Unit Specifications

Items	Specifications
Model	SI-S3/V (PCB model: SI-S3)
Communication Profile	DS 301 Ver. 4.02 DSP 402 Ver. 1.1 Velocity Mode
Connector	9 pin D-sub connector (#4/40 UNC thread)
Communications Speed	10 kbps to 1 Mbps
Ambient Temperature	-10 °C to +50 °C
Humidity	up to 95% RH (no condensation)
Storage Temperature	-20 °C to +60 °C (allowed for short-term transport of the product)
Area of Use	Indoor (free of corrosive gas, airborne particles, etc.)
Altitude	up to 1000 m



◆ Revision History

The revision dates and the numbers of the revised manuals appear on the bottom of the back cover.

MANUAL NO. SIEP C730600 24A

Published in Japan January 2008 07-9 

└─ Date of publication └─ Revision number
└─ Date of original publication

Date of Publication	Revision Number	Section	Revised Content
January 2011		Front cover	Revision: Format
		Chapter 4	Revision: LED status
			Deletion: Node ID Setup
		Chapter 6	Revision: Parameter table
		Chapter 7	Addition: Bit Rate and Node ID Setup
		Chapter 8	Revision: Object Dictionary description
			Addition: New object description
		Chapter 9	Addition: Configuring Manufacturer Specific Objects
		Chapter 10	Addition: Process Data Objects (PDO) and mapping instructions
		Chapter 11	Addition: Drive Parameter, Monitor and Control Resister Access
		Chapter 12	Addition: Fault-PE1, SDO Abort Codes
		Back cover	Revision: Address, format
June 2008		All	Revision: Reviewed and corrected entire documentation (including table of contents.)
		Chapter 6	Addition: Parameter F6-07, F6-08
		Chapter 8	Revision: Reviewed and corrected Manufacturer Specific Objects (DS 301), Drive and Motion Control (DSP 402), and Drive Error List.
		Chapter 9	Addition: Fault-oFA30 to oFA43 Monitor Faults and Alarms-AEr, CALL
		Chapter 10	Addition: MEMOBUS/Modbus Data Table
Back cover	Revision: Address		
January 2008		Back cover	Revision: Address
September 2007	–	–	First Edition

YASKAWA AC Drive-V1000 Option

CANopen

Technical Manual

DRIVE CENTER (INVERTER PLANT)

2-13-1, Nishimiyaichi, Yukuhashi, Fukuoka, 824-8511, Japan
Phone: 81-930-25-3844 Fax: 81-930-25-4369
<http://www.yaskawa.co.jp>

YASKAWA ELECTRIC CORPORATION

New Pier Takeshiba South Tower, 1-16-1, Kaigan, Minatoku, Tokyo, 105-6891, Japan
Phone: 81-3-5402-4502 Fax: 81-3-5402-4580
<http://www.yaskawa.co.jp>

YASKAWA AMERICA, INC.

2121 Norman Drive South, Waukegan, IL 60085, U.S.A.
Phone: (800) YASKAWA (927-5292) or 1-847-887-7000 Fax: 1-847-887-7310
<http://www.yaskawa.com>

YASKAWA ELÉTRICO DO BRASIL LTDA.

Avenda Fagundes Filho, 620 Bairro Saude, São Paulo, SP04304-000, Brasil
Phone: 55-11-3585-1100 Fax: 55-11-5581-8795
<http://www.yaskawa.com.br>

YASKAWA EUROPE GmbH

Hauptstrasse 185, 65760 Eschborn, Germany
Phone: 49-6196-569-300 Fax: 49-6196-569-398
<http://www.yaskawa.eu.com>

YASKAWA ELECTRIC UK LTD.

1 Hunt Hill Orchardton Woods, Cumbernauld, G68 9LF, United Kingdom
Phone: 44-1236-735000 Fax: 44-1236-458182
<http://www.yaskawa.co.uk>

YASKAWA ELECTRIC KOREA CORPORATION

7F, Doore Bldg. 24, Yeoido-dong, Yeongdungpo-gu, Seoul, 150-877, Korea
Phone: 82-2-784-7844 Fax: 82-2-784-8495
<http://www.yaskawa.co.kr>

YASKAWA ELECTRIC (SINGAPORE) PTE. LTD.

151 Lorong Chuan, #04-01, New Tech Park, 556741, Singapore
Phone: 65-6282-3003 Fax: 65-6289-3003
<http://www.yaskawa.com.sg>

YASKAWA ELECTRIC (SHANGHAI) CO., LTD.

No. 18 Xizang Zhong Road, 17F, Harbour Ring Plaza, Shanghai, 200001, China
Phone: 86-21-5385-2200 Fax: 86-21-5385-3299
<http://www.yaskawa.com.cn>

YASKAWA ELECTRIC (SHANGHAI) CO., LTD. BEIJING OFFICE

Room 1011, Tower W3 Oriental Plaza, No. 1 East Chang An Ave.,
Dong Cheng District, Beijing, 100738, China
Phone: 86-10-8518-4086 Fax: 86-10-8518-4082

YASKAWA ELECTRIC TAIWAN CORPORATION

9F, 16, Nanking E. Rd., Sec. 3, Taipei, 104, Taiwan
Phone: 886-2-2502-5003 Fax: 886-2-2505-1280



YASKAWA ELECTRIC CORPORATION

In the event that the end user of this product is to be the military and said product is to be employed in any weapons systems or the manufacture thereof, the export will fall under the relevant regulations as stipulated in the Foreign Exchange and Foreign Trade Regulations. Therefore, be sure to follow all procedures and submit all relevant documentation according to any and all rules, regulations and laws that may apply.

Specifications are subject to change without notice for ongoing product modifications and improvements.

© 2007-2011 YASKAWA ELECTRIC CORPORATION. All rights reserved.

MANUAL NO. SIEP C730600 24C

Published in Japan January 2011 07-9 -0
10-10-6