



**BRETZEL GmbH**  
Antriebs- und Elektrotechnik  
Am Rotböhl 8  
64331 Weiterstadt  
[www.bretzel-gmbh.de](http://www.bretzel-gmbh.de)  
[info@bretzel-gmbh.de](mailto:info@bretzel-gmbh.de)  
Telefon: 0 61 50 / 8 65 60 - 0

## INVERTER SERIES

Accessories & Options

EN



J1000  
A1000  
Accessories  
Options  
Inverter Series

## Content

- ▶ 02 **About YASKAWA**  
A Leader in Inverter Drives Technology
- ▶ 04 **System Configuration**
- ▶ 11 **AC Input Reactors**
- ▶ 12 **Standard EMC Filters**
- ▶ 13 **EMC Filters for IT Grid**
- ▶ 14 **Reactors for Lift and Escalator Applications**
- ▶ 15 **Harmonic Filters**
- ▶ 16 **Sine Wave Output Filters**
- ▶ 17 **Operators**  
Digital Operator  
IP65 Operator Mounting Frame
- ▶ 18 **Copy Unit**  
Control Power Supply
- ▶ 19 **Communication Option Cards**
- ▶ 20 **I/O Option Cards**  
Input, Output, Potentiometer  
Speed Feedback
- ▶ 21 **Mechanical Options**
- ▶ 22 **Braking Options**  
Braking Resistors  
Braking Units
- ▶ 23 **Motor Reactors**

## Experience and Innovation

Since 1915 YASKAWA has manufactured and supplied products for machine building and industrial automation. Our standard products as well as tailor-made solutions are well known and have a high reputation for outstanding quality and reliability.

YASKAWA is the leading global manufacturer of inverter drives, servo drives, machine controllers, medium voltage inverters, and industrial robots.

We have always been a pioneer in motion control and drive technology, launching product innovations, which optimise the productivity and efficiency of both machines and systems.



YASKAWA Eschborn, Germany

Today we produce more than 1.8 million inverters per year. Considering this, YASKAWA is probably the biggest inverter manufacturer in the world.



YASKAWA Motoman Robots

Furthermore, with a yearly production of more than 800,000 servo motors and 20,000 robots we offer a wide range of products for drive automation processes in many different industries. YASKAWA technology is used in all fields of machine building and industrial automation.

## A Leader in Inverter Drives Technology

Extensive research and development has allowed YASKAWA to remain at the forefront of motion control and automation technology. This technological leadership has helped to modernise industries such as mining, steel, pulp and paper, chemical, automotive, packaging, textile, lift, compressor and pump.



YASKAWA A1000 in Paper Industry



YASKAWA A1000 for Crane Applications, with IP 54 Chassis

## Wherever You Are – Our Local Support is Near.



Employing more than 14,600 people worldwide

More than 1,350 employees in worldwide service network

More than 1,200 employees in Europe



YASKAWA Allershausen, Germany

### A1000

A1000 is a premium high performance vector drive for use up to 630 kW and covers a broad application range from simple fan up to hoist, winder control, precise positioning and beyond. It provides built-in functional safety and is available in IP00, IP20, IP54 and as configurable Floor Standing Panel.



### 200 V Class Three Phase

Model CIMR-AC2A □	Max. applicable motor capacity [kW]		Standard EMC Filter	Braking Unit	Mechanical Options	
	Normal Duty	Heavy Duty			CDBR	Heatsink Ext. Mounting Kit
0004	0.75	0.55	FB-40008A	-	EZZ020800A	
0006	1.1	0.75				
0010	2.2	1.5	FB-40014A	-	EZZ020800A	
0012	3	2.2				
0021	5.5	4	FB-40025A	-	EZZ020800B	
0030	7.5	5.5				
0040	11	7.5	FB-40060A	-	EZZ020800B	
0056	15	11				
0069	18.5	15	FB-40072A	-	EZZ020800C	
0081	22	18.5				
0110	30	22	FB-40170A	2037D	EZZ020800D	100-054-500
0138	37	30				
0169	45	37	FB-40250A	2x 2022D	EZZ020800D	100-054-502
0211	55	45				
0250	75	55	FB-40414A	-	EZZ020800D	100-054-503
0312	90	75				
0360	110	90	FB-40675A	-	EZZ020800D	100-054-504
0415	110	110				

Find more details on page 12 22 21

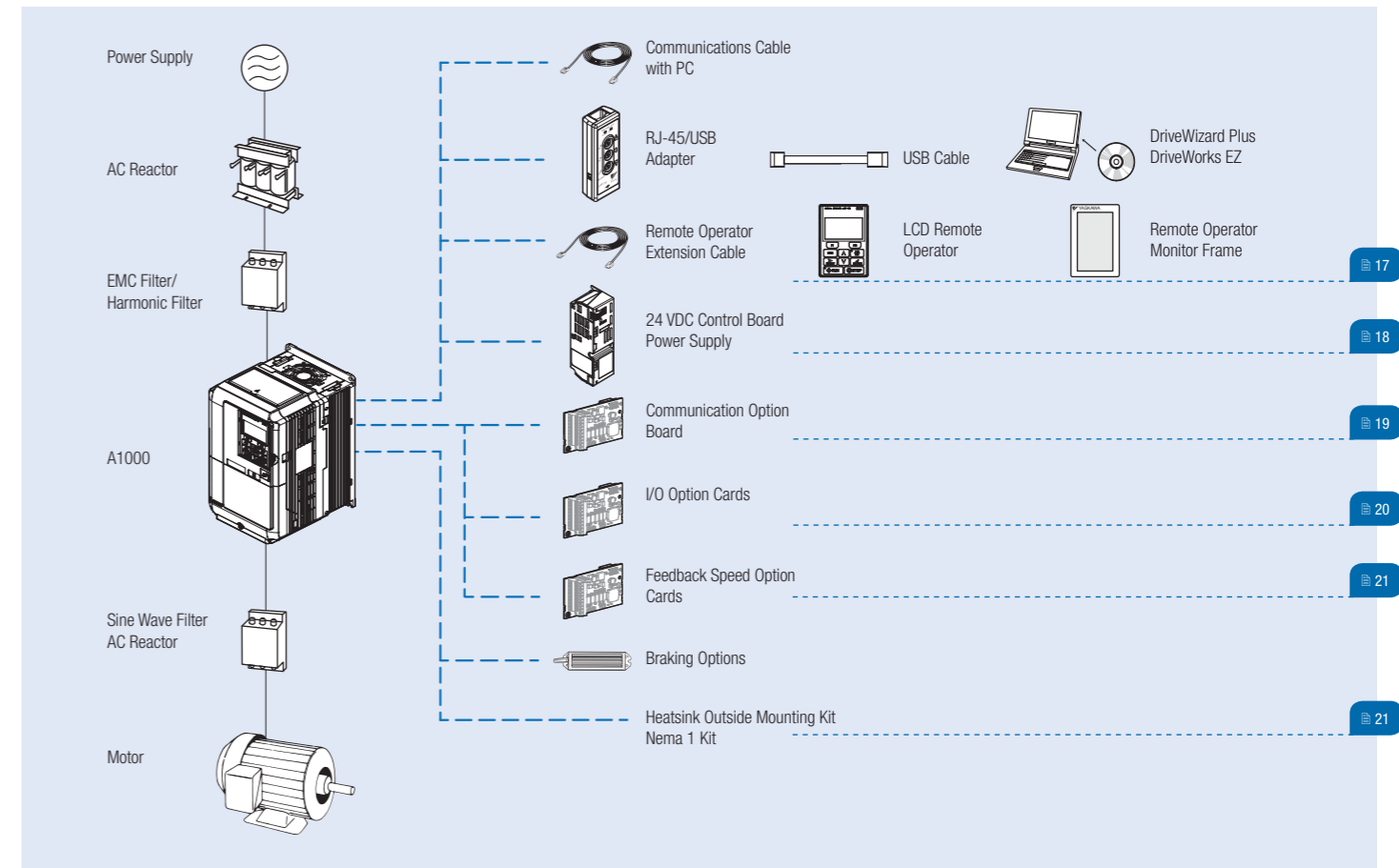

### 400 V Class Three Phase

Model CIMR-AC4A □	Max. applicable motor capacity [kW]		AC Input Reactor		Standard EMC Filter	EMC Filter for IT-Grid	Harmonic Filter		AC Output Reactor		Sine Wave Output Filter IP00/20	Braking Unit	Braking Resistor HD		Braking Resistor ND		Mechanical Options		Model CIMR-AC4A □
	Normal Duty	Heavy Duty	4%	2%			THD-1 8 %	THD-1 5 %	IP00	IP20			40% Duty Cycle	10% Duty Cycle	40% Duty Cycle	10% Duty Cycle	Heatsink Ext. Mounting Kit	NEMA Type 1 Kit	
0002	0.75	0.55	LR3 40-4/2	ALR3 40-2/2	FB-40008A	HLD 810-500/8	HF1K 7-400	HFM FB 7 400	MDB 400/6,3	MR3 400/4	SB-40004A-IP00 / IP20	Built-in	RH-0100W830	RH-0100W830	RH-0100W330	RH-0100W330	EZZ020800A		0002
0004	1.5	0.75	LR3 40-4/4	ALR3 40-2/4															
0005	2.2	1.5	LR3 40-4/6	ALR3 40-2/6	FB-40014A	HLD 810-500/16	HF1K 7-400	HFM FB 7 400	MDB 400/13	MR3 400/10	SB-40017A-IP00 / IP20	Built-in	RH-0520W120	RH-0520W120	RH-0520W120	RH-0520W120	EZZ020800B	-	0005
0007	3	2.2	LR3 40-4/10	ALR3 40-2/10															
0009	4	3	LR3 40-4/10	ALR3 40-2/10	FB-40025A	HLD 810-500/30	HF1K 13-400	HFM FB 13 400	MDB 400/24	MR3 400/24	SB-40024A-IP00 / IP20	Built-in	RH-0780W040	RH-0780W040-10	RH-0780W040	RH-0780W040-10	EZZ020800C		0009
0011	5.5	4	LR3 40-4/16	ALR3 40-2/16															
0018	7.5	5.5	LR3 40-4/20	ALR3 40-2/20	FB-40044A	HLD 810-500/42	HF1K 18-400	HFM FB 18 400	MDB 400/24	MR3 400/24	SB-40037A-IP00 / IP20	Built-in	RH-1560W040	RH-1560W040-10	RH-1560W040	RH-1560W040-10	EZZ020800D		0018
0023	11	7.5	LR3 40-4/25	ALR3 40-2/25															
0031	15	11	LR3 40-4/45	ALR3 40-2/45	FB-40060A	HLD 810-500/55	HF1K 30-400	HFM FB 30 400	MDB 400/46	MR3 4000/48	SB-40048A-IP00 / IP20	Built-in	RH-4800W022	RH-4800W022-10	RH-4800W22	RH-4800W022-10	EZZ020800D		0031
0038	18.5	15	LR3 40-4/63	ALR3 40-2/63															
0058	30	22	LR3 40-4/70	ALR3 40-2/70	FB-40072A	HLD 810-500/75	HF1K 50-400	HFM FB 50 400	MDB 400/72	MR3 400/61	SB-40072A-IP00 / IP20	Built-in	RH-6000W022	RH-6000W022-10	RH-6000W022	RH-6000W022-10	EZZ020800D		0058
0072	37	30	LR3 40-4/90	ALR3 40-2/90															
0088	45	37	LR3 40-4/90	ALR3 40-2/90	FB-40105A	HLD 810-500/100	HF1K 70-400	HFM FB 70 400	MDB 400/110	MR3 400/110	SB-40115A-IP00	4045D	RH-9600W015	RH-9600W015-10	RH-9600W015	RH-9600W015-10	EZZ020800D		0088
0103	55	45	LR3 40-4/115	ALR3 40-2/115															
0139	75	55	LR3 40-4/160	ALR3 40-2/160	FB-40170A	HLD 810-500/180	HF1K 100-400	HFM FB 100 400	MDB 400/176	MR3 400/176	SB-40180A-IP00	2x 4045D	2x RH9600W015	2x RH-9600W015-10	2x RH9600W015	2x RH-9600W015-10	EZZ020800D		0139
0165	90	75	LR3 40-4/200	ALR3 40-2/200															
0208	110	90	LR3 40-4/250	ALR3 40-2/250	FB-40250A	HLD 810-500/250	HF1K 200 400	HFM FB 200 400	B1107115		SB-40250A-IP00	4220B	RH-29000W3P8-10	RH-29000W3P8-10	RH-38500W3P8-10	RH-38500W3P8-10	EZZ020800D		0208
0250	132	110	LR3 40-4/300	ALR3 40-2/300															
0296	160	132	LR3 40-4/400	ALR3 40-2/400	FB-40414A	HLD 803-500/415	HF1K 255 400	HFM FB 255 400	B1107115		SB-40414A-IP00	4220B	RH-48000W3P8-10	RH-48000W3P8-10	RH-48000W3P8-10	RH-48000W3P8-10	EZZ020800D		0296
0362	185	160	LR3 40-4/400	ALR3 40-2/400															
0414	220	185	LR3 40-4/500	ALR3 40-2/500	FB-40675A	HLD803-500/675	HF1K 300 400	HFM FB 300 400	B1107116		SB-40675A-IP00	2x 4220B	2x RH-29000W3P8-10	2x RH-29000W3P8-10	2x RH-29000W3P8-10	2x RH-29000W3P8-10	EZZ020800D		0414
0515	250	220	LR3 40-4/710	ALR3 40-2/710															
0675	355	315	LR3 40-4/1200	ALR3 40-2/1200	FB-41200A	on Request	B 1108040	HFM FB 225 400	B1107117		SB-41200A-IP00	on Request	on Request	on Request	on Request	on Request	EZZ020800D		0675
0930	500	450	LR3 40-4/1200	ALR3 40-2/1200															
1200	630	560	LR3 40-4/1200	ALR3 40-2/1200	FB-41200A	on Request	B 1108043	HFM FB 225 400	B1107117		SB-41200A-IP00	on Request	on Request	on Request	on Request	on Request	EZZ020800D		1200
			LR3 40-4/1200	ALR3 40-2/1200															

Find more details on page 11 12 13 15 23 16 22 21

\*1 when using 8 kHz choose MDB 400/46.  
\*2 when using 8 kHz choose MR3 400/37.

## V1000

The general purpose vector control inverter V1000 is designed for use with induction and PM motors. Functional Safety and PLC functionality is built-in. The V1000 supports all major field bus systems and is available in IP20, IP66 and Cold Plate. Major applications for the V1000 range from lower demanding to heavy duty applications such as compressors or hoists.



### 200 V Class Single Phase

Model CIMR-VCBA □	Max. applicable motor capacity [kW]		Standard EMC Filter	Braking Resistor HD		Braking Resistor ND		Mechanical Options	
	Normal Duty	Heavy Duty		40% Duty Cycle	10% Duty Cycle	40% Duty Cycle	10% Duty Cycle	Heatsink Ext. Mounting Kit	DIN Rail Mounting Kit
0001	0.18	0.1	FS23638-10-07	RH-0100W830	RH-0100W830	RH-0100W330	RH-0100W330	EZZ020568A	EZZ08122A
0002	0.37	0.18		RH-0100W330	RH-0100W330				
0003	0.75	0.55	FS23638-20-07	RH-0260W270	RH-0260W270	RH-0260W135	RH-0260W135	EZZ020568B	EZZ08122B
0006	1.1	0.75		RH-0260W135	RH-0260W135				
0010	2.2	1.5	FS23638-30-07	RH-0390W070	RH-0390W070	RH-0390W070	RH-0390W070	EZZ020568C	EZZ08122C
0012	3.0	2.2		RH-0390W070	RH-0390W070				
0018	-	4.0	FS23638-40-07	RH-0780W040	RH-0780W040-10	RH-0780W040	RH-0780W040-10	EZZ020568E	EZZ08122D

### 200 V Class Three Phase

Model CIMR-VC2A □	Max. applicable motor capacity [kW]		Standard EMC Filter	Braking Resistor HD		Braking Resistor ND		Mechanical Options	
	Normal Duty	Heavy Duty		40% Duty Cycle	10% Duty Cycle	40% Duty Cycle	10% Duty Cycle	Heatsink Ext. Mounting Kit	DIN Rail Mounting Kit
0001	0.18	0.1	FS23637-8-07	RH-0100W830	RH-0100W830	RH-0100W330	RH-0100W330	EZZ020568A	EZZ08122A
0002	0.37	0.2		RH-0100W330	RH-0100W330				
0004	0.75	0.4	FS23637-8-07	RH-0260W270	RH-0260W270	RH-0260W135	RH-0260W135	EZZ020568B	EZZ08122B
0006	1.1	0.75		RH-0260W135	RH-0260W135				
0010	2.2	1.5	FS23637-14-07	RH-0390W070	RH-0390W070	RH-0390W070	RH-0390W070	EZZ020568D	EZZ08122B
0012	3.0	2.2	FS23637-14-07	RH-0390W070	RH-0390W070	RH-0390W070	RH-0390W070		
0020	5.5	4.0	FS23637-24-07	RH-0780W040	RH-0780W040-10	RH-0780W040	RH-0780W040-10	EZZ020568E	EZZ08122C
0030	7.5	5.5	FS23637-52-07	RH-0780W040	RH-0780W040-10	RH-9600W015	RH-9600W015-10	EZZ020568H	-
0040	11.0	7.5		RH9600W015	RH9600W015-10				
0056	15.0	11.0	FS23637-68-07	RH9600W015	RH9600W015-10	RH-9600W015	RH-9600W015-10	EZZ020568J	-
0069	18.5	15.0	FS23637-80-07	RH9600W015	RH9600W015-10	RH-9600W015	RH-9600W015-10	EZZ020568K	

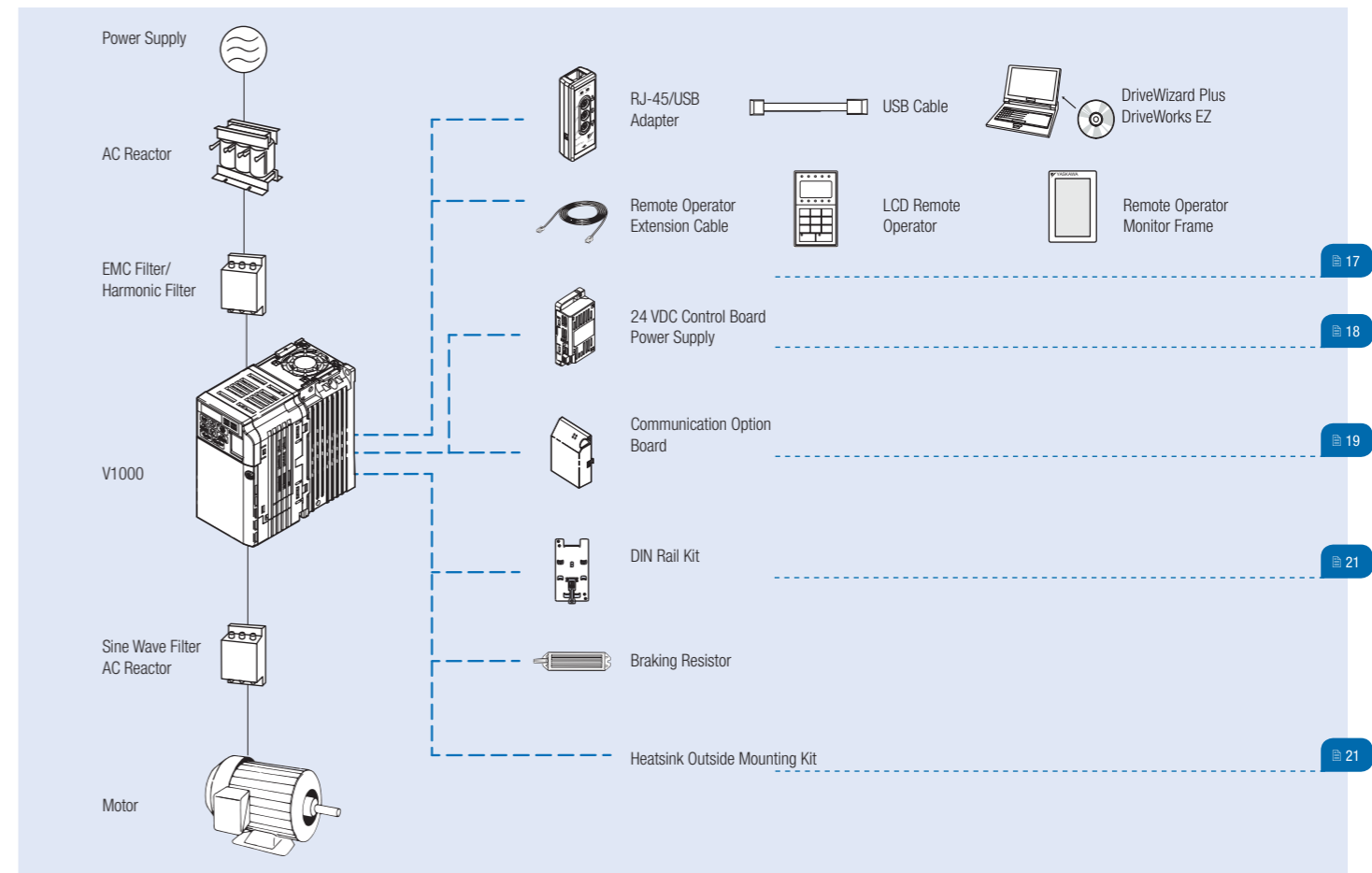

### 400 V Class Three Phase

Model CIMR-VC4A □	Max. applicable motor capacity [kW]		AC Input Reactor		Standard EMC Filter	Harmonic Filter		AC Output Reactor	
	Normal Duty	Heavy Duty	4%	2%		THD-I 8 %	THD-I 5 %	IP00	IP20
0001	0.37	0.18	LR3 40-4/2	ALR3 40-2/2	FS23639-5-07	HF1K 7-400	HFM FB 7 400	MDB 400/6,3	MR3 400/4
0002	0.75	0.37							MR3 400/10
0004	1.5	0.75	LR3 40-4/4	ALR3 40-2/4	FS23639-10-07	HF1K 7-400	HF1K 7-400	MDB 400/6,3	MR3 400/10
0005	2.2	1.5							MR3 400/10
0007	3.0	2.2	LR3 40-4/10	ALR3 40-2/10	FS23639-10-07	HF1K 7-400	HF1K 7-400	MDB 400/13	MR3 400/10
0009	4.0	3.0							MR3 400/10
0011	5.5	4.0	LR3 40-4/16	ALR3 40-2/16	FS23639-15-07	HF1K 13-400	HFM FB 13 400	MDB 400/24	MR3 400/18
0018	7.5	5.5							MR3 400/24
0023	11	7.5	LR3 40-4/25	ALR3 40-2/25	FS23639-30-07	HF1K 18-400	HFM FB 18 400	MDB 400/24 or 46 **	MR3 400/24 or 37 **
0031	15	11.0							MR3 400/24 or 37 **
0038	18.5	15.0	LR3 40-4/45	ALR3 40-2/45	FS23639-50-07	HF1K 30-400	HFM FB 30 400	MDB 400/46	MR3 4000/48

Sine Wave Output Filter IP00/20	Braking Resistor HD		Braking Resistor ND		Mechanical Options		Model CIMR-VC4A □
	40% Duty Cycle	10% Duty Cycle	40% Duty Cycle	10% Duty Cycle	Heatsink Ext. Mounting Kit	DIN Rail Mounting Kit	
SB-40004A-IP00 / IP20	RH-0100W830	RH-0100W830	RH-0100W830	RH-0100W830	EZZ020568L	EZZ08122B	0001
SB-40010A-IP00 / IP20	RH-0260W270	RH-0260W270	RH-0260W270	RH-0260W270	EZZ020568C		0002
SB-40017A-IP00 / IP20					EZZ020568D	0004	
SB-40017A-IP00 / IP20	RH-0520W120	RH-0520W120	RH-0520W120	RH-0520W120	EZZ020568D	0005	
SB-40024A-IP00 / IP20					EZZ020568E	0007	
SB-40024A-IP00 / IP20	RH-0780W040	RH-0780W040-10	RH-0780W040	RH-0780W040-10	EZZ020568E	EZZ020568C	0009
SB-40037A-IP00 / IP20					EZZ020568H	0011	
SB-40037A-IP00 / IP20	RH-1560W040	RH-1560W040-10	RH-1560W040	RH-1560W040-10	EZZ020568H	-	0018
SB-40048A-IP00 / IP20					EZZ020568J		0023
SB-40048A-IP00 / IP20	RH-4800W022	RH-4800W022-10	RH-4800W022	RH-4800W022-10	EZZ020568J	-	0031

### J1000

J1000 is the compact inverter drive from YASKAWA. With its easy set-up with just a few number of settings it perfectly suits low demanding applications.

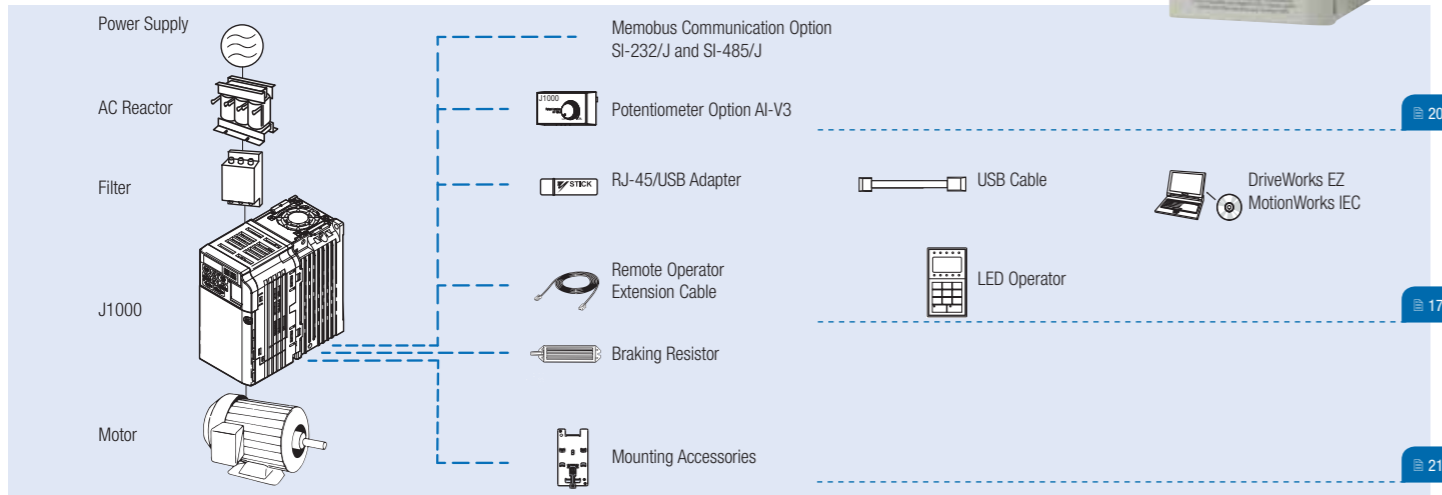

### 200 V Class Single Phase

Model CIMR-JCBA □	Max. applicable motor capacity [kW]		Standard EMC Filter	Braking Resistor HD		Braking Resistor ND		Mechanical Options		
	Normal Duty	Heavy Duty		40% Duty Cycle	10% Duty Cycle	40% Duty Cycle	10% Duty Cycle	Heatsink Ext. Mounting Kit	DIN Rail Mounting Kit	NEMA Type1 Kit
0001	0.2	0.1	FS23638-10-07	RH-0100W830	RH-0100W830	RH-0100W330	RH-0100W330	EZZ020568A	EZZ08122A	EZZ020564A
0002	0.4	0.2		RH-0100W330	RH-0100W330	RH-0260W270	RH-0260W270	EZZ020568B		
0003	0.75	0.4		RH-0260W135	RH-0260W135	RH-0260W135	RH-0260W135	EZZ020568C		
0006	1.1	0.75	FS23638-20-07	RH-0260W135	RH-0260W135	RH-0260W135	RH-0260W135	EZZ020568C	EZZ08122B	EZZ020564C
0010	2.2	1.5		RH-0390W070	RH-0390W070	RH-0390W070	RH-0390W070	EZZ020568D		

### 200 V Class Three Phase

Model CIMR-JC2A □	Max. applicable motor capacity [kW]		Standard EMC Filter	Braking Resistor HD		Braking Resistor ND		Mechanical Options		
	Normal Duty	Heavy Duty		40% Duty Cycle	10% Duty Cycle	40% Duty Cycle	10% Duty Cycle	Heatsink Ext. Mounting Kit	DIN Rail Mounting Kit	NEMA Type1 Kit
0001	0.2	0.1	FS23637-8-07	RH-0100W830	RH-0100W830	RH-0100W330	RH-0100W330	EZZ020568A	EZZ08122A	EZZ020564A
0002	0.4	0.2		RH-0100W330	RH-0100W330	RH-0260W270	RH-0260W270	EZZ020568B		
0004	0.75	0.4		RH-0260W135	RH-0260W135	RH-0260W135	RH-0260W135	EZZ020568G		
0006	1.1	0.75		RH-0260W135	RH-0260W135	RH-0260W135	RH-0260W135	EZZ020568G		
0010	2.2	1.5	FS23637-14-07	RH-0390W070	RH-0390W070	RH-0390W070	RH-0390W070	EZZ020568D	EZZ08122B	EZZ020564G
0012	3.0	2.2		RH-0390W070	RH-0390W070	RH-0390W070	RH-0390W070	EZZ020568D		
0020	5.5	4.0	FS23637-24-07	RH-0780W040	RH-0780W040-10	RH-0780W040	RH-0780W040-10	EZZ020568E	EZZ08122C	EZZ020564H

### 400 V Class Three Phase

Model CIMR-JC4A □	Max. applicable motor capacity [kW]		Standard EMC Filter	Braking Resistor HD		Braking Resistor ND		Mechanical Options		
	Normal Duty	Heavy Duty		40% Duty Cycle	10% Duty Cycle	40% Duty Cycle	10% Duty Cycle	Heatsink Ext. Mounting Kit	DIN Rail Mounting Kit	NEMA Type1 Kit
0001	0.4	0.2	FS23639-5-07	RH-0100W830	RH-0100W830	RH-0100W830	RH-0100W830	EZZ020568L	EZZ08122B	EZZ020564G
0002	0.75	0.4		RH-0100W830	RH-0100W830	RH-0260W270	RH-0260W270	EZZ020568C		
0004	1.5	0.75		RH-0260W270	RH-0260W270	RH-0260W270	RH-0260W270	EZZ020568D		
0005	2.2	1.5	FS23639-10-07	RH-0260W270	RH-0260W270	RH-0260W270	RH-0260W270	EZZ020568D	EZZ08122B	EZZ020564J
0007	3.0	2.2		RH-0520W120	RH-0520W120	RH-0520W120	RH-0520W120	EZZ020568E		
0009	3.7	3.0	FS23639-15-07	RH-0520W120	RH-0520W120	RH-0520W120	RH-0520W120	EZZ020568E	EZZ08122C	EZZ020564H
0011	5.5	3.7		RH-0520W120	RH-0520W120	RH-0520W120	RH-0520W120	EZZ020568E		

### L1000A

The YASKAWA L1000A provides many technical features and a special design which enhance product applicability and reliability for first class efficiency.



### 200 V Class Three Phase

Model CIMR-LC2A □	Max. applicable motor capacity [kW]	Standard EMC Filter	AC Input Reactor for Lift		Braking Unit CDBR
			IP00	IP20	
0008	1.5	FB-40014A	LR3 40-4/16	LR3 40-4/16-IP20	-
0011	2.2				
0018	4	FB-40025A	LR3 40-4/20	LR3 40-4/20-IP20	
0025	5.5				
0033	7.5	FB-40060A	LR3 40-4/45	LR3 40-4/45-IP20	
0047	11				
0060	15	FB-40072A	LR3 40-4/70	LR3 40-4/70-IP20	
0075	18.5				
0085	22	FB-40105A	LR3 40-4/90	LR3 40-4/90-IP20	
0115	30				
0145	37	FB-40170A	LR3 40-4/115	LR3 40-4/115-IP20	
0180	45				
0215	55	FB-40250A	LR3 40-4/160	LR3 40-4/160-IP20	2037D
0283	75				
0346	90	FB-40250A	LR3 40-4/200	LR3 40-4/200-IP20	2x 2022D
0415	110				
Find more details on page			12	14	22

\*1 when using 8 kHz choose MDB 400/46.  
\*2 when using 8 kHz choose MR3 400/37.

### 400 V Class Three Phase

Model CIMR-LC4A □	Max. applicable motor capacity [kW]	Standard EMC Filter	AC Input Reactor for Lift		Harmonic Filter		AC Output Reactor		Sine Wave Output Filter IP00/20	Braking Unit CDBR	Braking Resistor HD
			IP00	IP20	THD-I 8 %	THD-I 5 %	IP00	IP20			
0005	2.2	FB-40008A	B 0903084	B 0903088	HF1K 7-400	HFM FB 7 400	MDB 400/13	MR3 400/10	SB-40010A-IP00 / IP20	Built-in	
0006	3				HF1K 13-400	HFM FB 13 400	MDB 400/24	MR3 400/18			
0009	4	FB-40014A	B 0903085	B 0903089	HF1K 18-400	HFM FB 18 400	MDB 400/24	MR3 400/24	SB-40024A-IP00 / IP20	Built-in	RH-1000W120
0015	5.5				HFM FB 18 400	MDB 400/24 or 46*	MR3 400/24 or 37*	RH-1560W040			
0018	7.5	FB-40025A	B 0903086	B 0903090	HF1K 30-400	HFM FB 30 400	MDB 400/46	MR3 400/48	SB-40037A-IP00 / IP20	Built-in	RH-2700W025
0023	11				HFM FB 30 400	MDB 400/46	MR3 400/48	RH-3700W025			
0031	15	FB-40044A	B 0903087	B 0903091	HF1K 50-400	HFM FB 50 400	MDB 400/72	MR3 400/61	SB-40048A-IP00 / IP20	Built-in	RH-4800W022
0039	18.5				HFM FB 50 400	MDB 400/72	MR3 400/61	RH-4800W022			
0045	22	FB-40060A	B 0910009	B 0910014	HF1K 70-400	HFM FB 70 400	MDB 400/110	-	SB-40115A-IP00	4045D	RH-6000W022
0060	30				HFM FB 70 400	MDB 400/110	RH-7500W023				
0075	37	FB-40105A	B 0910011	B 0910016	HF1K 100-400	HFM FB 100 400	MDB 400/176	-	SB-40180A-IP00	2x 4030D	2x RH-6000W022
0091	45				HFM FB 100 400	MDB 400/176	RH-9600W015				
0112	55	FB-40170A	B 0910013	B 0910018	HF1K 150-400	HFM FB 150 400	B1107115	-	SB-40250A-IP00		
0150	75				HFM FB 150 400	B1107115					
0180	90	FB-40250A	-	-	HF1K 200-400	HFM FB 200 400	-	-			
0216	110				HFM FB 200 400						
Find more details on page			12	14	15	23	16	22			

### L1000V

The L1000V is the drive of choice for retrofit or new installation of open loop driven, geared lifts with speeds up to 1.0 m/s.



#### 200 V Class Three Phase

Model CIMR-LC2V □	Max. applicable motor capacity [kW]	Standard EMC Filter	AC Input Reactor for Lift		Braking Resistor HD
			IP00	IP20	
0018	4.0	FS23637-24-07	LR3 40-4/20	LR3 40-4/20-IP20	RH-1560W040
0025	5.5	FS23637-52-07	LR3 40-4/45	LR3 40-4/45-IP20	RH-2700W025
0033	7.5				
0047	11.0	FS23637-68-07	LR3 40-4/70	LR3 40-4/70-IP20	RH-3700W025
0060	15.0	FS23637-80-07			
Find more details on page		12	14		22

#### 400 V Class Three Phase

Model CIMR-LC4V □	Max. applicable motor capacity [kW]	Standard EMC Filter	AC Input Reactor for Lift		Harmonic Filter		AC Output Reactor		Sine Wave Output Filter IP00/20	Braking Resistor HD
			IP00	IP20	THD-I 8 %	THD-I 5 %	IP00	IP20		
0009	4.0	FS23639-15-07	B 0903084	B 0903088	HF1K 13-400	HFM FB 13 400	MDB 400/24	MR3 400/18	SB-40024A-IP00 / IP20	RH-1000W120
0015	5.5	FS23639-30-07	B 0903085	B 0903089	HF1K 18-400	HFM FB 13 400	MDB 400/24	MR3 400/24	SB-40024A-IP00 / IP20	RH-1000W120
0018	7.5									
0024	11.0	FS23639-50-07	B 0903086	B 0903090	HF1K 30-400	HFM FB 30 400	MDB 400/24 or 46 *1	MR3 400/24 or 37 *2	SB-40037A-IP00 / IP20	RH-1560W040
0031	15.0									
Find more details on page		22	14		15	23		16	22	



YASKAWA Lift Inverters make Motion a Pleasure – for Passengers and Operators

### AC Input Reactors

This reactor type is used to suppress harmonic currents and to improve the total power factor. It prevents the rectifier from harmonics and sudden variation of power voltage.



#### Specifications

Ambient Temperature	-10 to +40 °C
Standards	DIN EN 61558-2-20 IEC 61558-2-20 UL 506 CSA 22.2
Approvals	UL 506 CSA 22.2
Protection Class	IP 00

#### 2% Short Circuit Voltage to Mains

Order Code	A	B	C	Weight (kg)
	(mm)			
ALR3 40-2/2	54	78	87	0.5
ALR3 40-2/4	54	78	87	0.5
ALR3 40-2/6	64	78	87	1.1
ALR3 40-2/10	76	96	107	1.5
ALR3 40-2/16	76	127	125	2
ALR3 40-2/20	76	127	125	2
ALR3 40-2/25	89	127	125	2.9
ALR3 40-2/45	102	152	163	3.8
ALR3 40-2/63	102	178	188	6.8

#### 4% Short Circuit Voltage to Mains

Order Code	A	B	C	Weight (kg)
	(mm)			
LR3 40-4/2	56	78	100	0.5
LR3 40-4/4	60	96	117	1.3
LR3 40-4/6	69	96	117	1.5
LR3 40-4/10	85	120	140	2
LR3 40-4/16	95	120	140	2.7
LR3 40-4/20	95	155	162	3.8
LR3 40-4/25	110	155	177	5.8
LR3 40-4/45	112	185	210	8.3
LR3 40-4/63	122	185	210	9.7
LR3 40-4/70	117	210	240	10.8
LR3 40-4/90	149	276	200	16
LR3 40-4/115	179	291	210	21
LR3 40-4/160	189	291	210	25.5
LR3 40-4/200	194	352	260	32
LR3 40-4/250	207	352	260	41
LR3 40-4/300	219	352	260	48
LR3 40-4/400	234	352	260	56
LR3 40-4/500	245	352	260	62
LR3 40-4/710	235	480	380	102
LR3 40-4/1200	330	555	445	

#### Dimensions

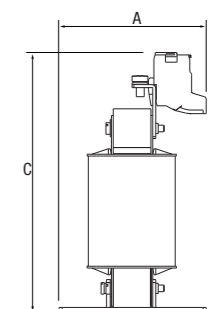
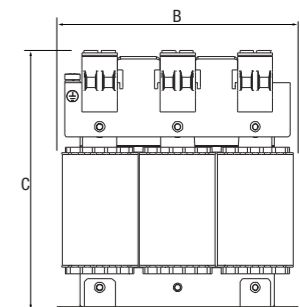

### Standard EMC Filters

Filter for power supply side for electromagnetic interference suppression of single and multiple drives.



#### Specifications

Ambient Temperature	max. +50 °C
Standards	EN 60939-2
Protection Class	IP 00

Order Code	Rated Current (A)	EN61800-3: Class	A	B	C	Weight (kg)	Terminals		Foot Mount	
			(mm)				Phase	PE		
FB-40008A	8	C1 (25m) and C2 (50m)	301	140	50	2.3	3× 2.5	M5	yes	
FB-40014A	14		301	140	50	2.4				
FB-40025A	25		301	140	50	3				
FB-40044A	44	C2 (50m)	341	180	60	4.3	3× 16	M8	no	
FB-40060A	60		310	85	135	4.5	35 mm <sup>2</sup>			
FB-40072A	72		310	85	135	4.7				
FB-40105A	105		325	95	150	5.3	50 mm <sup>2</sup>			M10
FB-40170A	170		440	130	181	9.4	95 mm <sup>2</sup>			
FB-40250A	250		525	155	220	12.4	150 mm <sup>2</sup>			M12
FB-40414A	414		500	300	130	26.5	25×6 (ØM12)			
FB-40675A	675		500	300	130	28.5	30×10 (ØM12)			
FB-41200A	1200		716	300	160	49.6	50×12 (ØM12)			

#### Dimensions Without Foot Mount

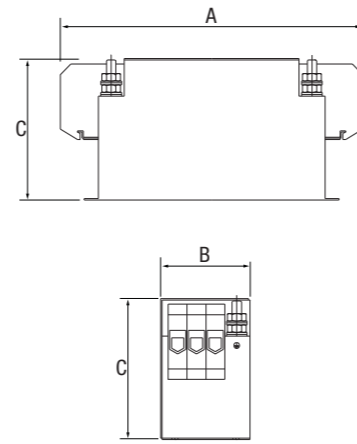

Order Code	Rated Current (A)	EN61800-3: Class	A	B	C	Weight (kg)	Terminals		Foot Mount
			(mm)				Phase	PE	
FS23637-8-07	7,3	C1	169	71	40	0.4	1 mm <sup>2</sup>	M5	no
FS23637-14-07	14		169	111	45	0.6	1,5 mm <sup>2</sup>		
FS23637-24-07	24		174	144	50	0.9	4 mm <sup>2</sup>		
FS23637-52-07	52		304	137	56	2	6 mm <sup>2</sup>		
FS23637-68-07	68		304	175	65	2.6	10 mm <sup>2</sup>		
FS23637-80-07	80	393	212	65	3.1	16 mm <sup>2</sup>	M8		
FS23638-10-07	10	C1	169	71	45	0.5	1,5 mm <sup>2</sup>	M5	no
FS23638-20-07	20		169	111	50	0.75	2,5 mm <sup>2</sup>		
FS23638-30-07	30		174	144	50	1.1	4 mm <sup>2</sup>		
FS23638-40-07	40	174	174	50	1.3	6 mm <sup>2</sup>			
FS23639-5-07	5	C1	169	111	45	0.5	1,5 mm <sup>2</sup>	M5	no
FS23639-10-07	10		169	111	45	0.7			
FS23639-15-07	15		174	144	50	0.9	2,5 mm <sup>2</sup>		
FS23639-30-07	30		304	137	56	1.8	4 mm <sup>2</sup>		
FS23639-50-07	50		340	175	65	2.7	6 mm <sup>2</sup>		

#### Dimensions With Foot Mount

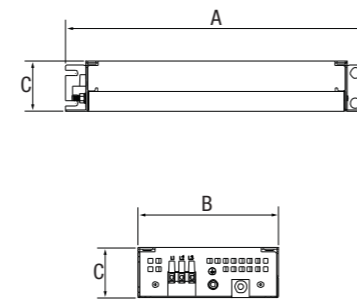

### EMC Filters for IT Grid

Filter for power supply side EMI suppression of single or multiple drives in isolated networks (IT grid).



#### Specifications

Ambient Temperature	max. +50 °C
Approvals	cURus UL 1283 5th edition CSA C22.2 No.8
Protection Class	IP 20

Order Code	Rated Current (A)	EN61800-3: Class	A	B	C	Terminals		Weight (kg)
			(mm)			Phase	PE	
HLD 810-500/8	8	C3 (10m)*	190	45	75	4 mm <sup>2</sup>	M5	0.8
HLD 810-500/16	16		250	45	75			1.2
HLD 810-500/30	30		270	55	95	10 mm <sup>2</sup>	M5	1.8
HLD 810-500/42	42		310	55	95			2.1
HLD 810-500/55	55		250	85	95	16 mm <sup>2</sup>	M6	2.5
HLD 810-500/75	75		270	85	135	35 mm <sup>2</sup>	M8	4.5
HLD 810-500/100	100		270	95	150	50 mm <sup>2</sup>	M10	5.2
HLD 810-500/130	130		270	95	150			5.6
HLD 810-500/180	180		380	130	181	95 mm <sup>2</sup>	M10	9.2
HLD 810-500/250	250		450	155	220	150 mm <sup>2</sup>	M12	12.2
HLD 803-500/415	415		500	280	130	25×6 (ØM12)	M12	24
HLD 803-500/675	675		500	280	130	30×10 (ØM12)	M12	27

\* There are no EMC limits according to norms. The C3 level list just for information.

#### Dimensions

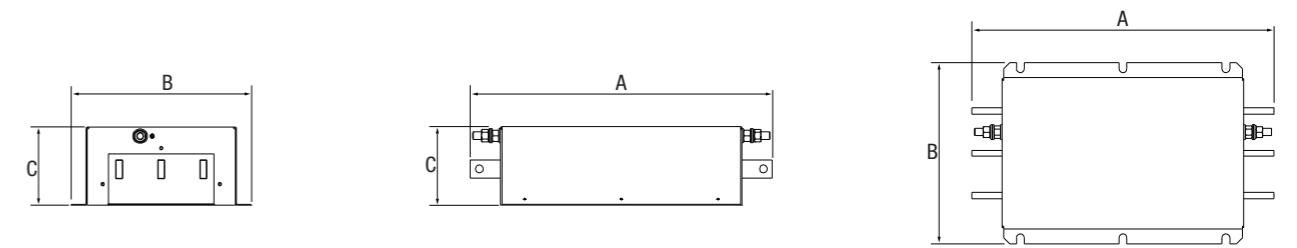

## Reactors for Lift and Escalator Applications

These reactors are used at the output of drives in order to improve the power factor and to comply with requirements to harmonic distortion units resulting from EN12015.

### Specifications

Ambient Temperature	-10 to +50 °C
Standards	VDE 0570 / EN 61 558 Part 1 VDE 0570 / EN 61 558 Part 20

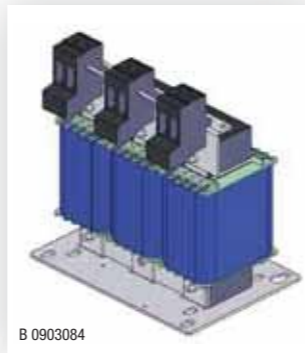

B 0903084

### With IP00 Chassis

Order Code	Rated Current	Inductance (mH)	A	B	C	Weight (kg)
	(A)					
B 0903084	8	10	110	155	170	6
B 0903085	16	5.1	102	185	196	7.1
B 0903086	21	4.7	125	210	220	9.1
B 0903087	27	3.15	135	210	220	10.7
B 0910009	38	2	166	230	205	12.5
B 0910011	65	1.3	166	263	205	25
B 0910013	96	0.9	180	330	270	36.4

### Dimensions of IP00 Chassis

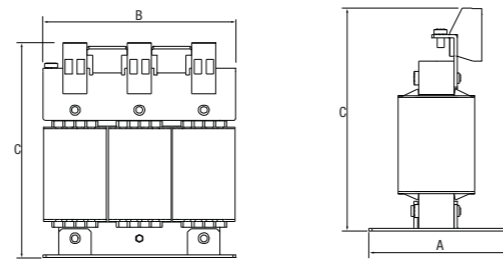

B0903088

### With IP20 Chassis

Order Code	Rated Current	Inductance (mH)	A	B	C	Weight (kg)
	(A)					
B 0903088	8	10	190	275	210	7
B 0903089	16	5.1				8.1
B 0903090	21	4.7	195	345	240	12
B 0903091	27	3.15				12.5
B 0910014	38	2	240	395	280	14.4
B 0910016	65	1.3				27.5
B 0910018	96	0.9				39

### Dimensions of IP20 Chassis

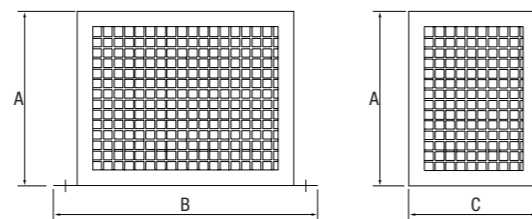

## Harmonic Filters

Provide sinusoidal input current helping to comply with power quality standards like IEEE519 or EN61000-312. Furthermore harmonic filters reduce the electrical and thermal burden on the power supply infrastructure.

### Specifications

Ambient Temperature	-10 °C to +40 °C
Standards	EN 61558 Part 1 EN 61558 Part 20 UL 508 17th Ed. CSA 22.2 No. 14-10
Approvals :	UL 506, CSA 22.2



### Total Harmonic Distortion THD-I < 8%

Order Code	Rated Current (A)	A B C			Terminals		Weight (kg)
		(mm)			Phase	PE	
HF1K 7-400	10	231	375	235	10 mm <sup>2</sup>	M6	14
HF1K 13-400	19	275	440	270			28
HF1K 18-400	26	272	425	270			31
HF1K 30-400	44	290	545	350			59
HF1K 50-400	73	320	545	315	M8 bolt	M8	75,5
HF1K 70-400	102	348	685	460			125
HF1K 100-400	144	375	685	460			163

### Dimensions for THD-I < 8%

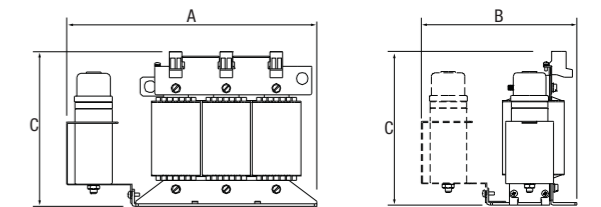

### Total Harmonic Distortion THD-I < 5%

Order Code	Rated Current (A)	A B C			Terminals		Weight (kg)
		(mm)			Phase	PE	
HFM FB 7 400	10	455	165	242	16 mm <sup>2</sup>	M8	27
HFM FB 13 400	19	455	165	242			28
HFM FB 18 400	26	645	365	225			40
HFM FB 30 400	43	885	357	225			52
HFM FB 50 400	72	885	357	225	50 mm <sup>2</sup>	M8	88
HFM FB 70 400	101	1060	393	400			150
HFM FB 100 400	144	1060	393	400	150 mm <sup>2</sup>	M8	167
HFM FB 125 400	180	1160	454	420			178
HFM FB 150 400	217	1160	454	420			224
HFM FB 200 400	289	1330	545	420	95 mm <sup>2</sup>	M8	271
HFM FB 225 400	325	1330	545	420			284
HFM FB 255 400	370	1350	530	420	240 mm <sup>2</sup>	M8	310
HFM FB 300 400	433	1350	530	420			387
B 1108040	500	1700	540	600	45x4 mm / 2x Ø15 mm	M12	460
B 1108043	900	1700	540	1000	45x4 mm / 2x Ø15 mm		750

### Dimensions for THD-I < 5%

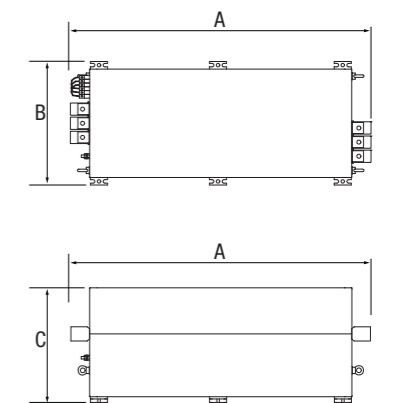



## Sine Wave Output Filter

This filter type smoothens the drive output voltage and suppresses differential mode interference, thus improves motor service life and EMC environment. Recommended also for very long, unshielded motor cables.

### Specifications

Ambient Temperature	-10 to +50 °C
Standards	EN 61 558 Part 1 EN 61 558 Part 20 UL 508
Approvals	CE, cURus

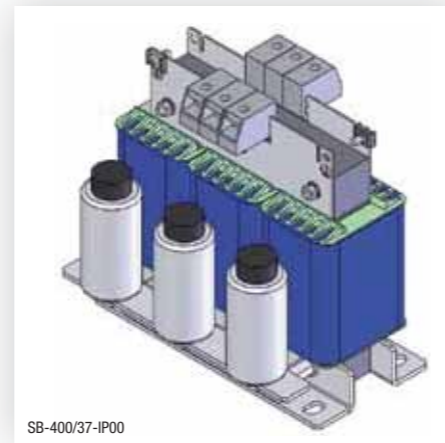

### With IP00 Chassis

Order Code	Current	A	B	C	Terminals		Weight
	(A)				(mm)	Phase	
SB-40004A-IP00	4	105	155	160	4 mm <sup>2</sup>	M4	12
SB-40010A-IP00	10	120	155	160			15,5
SB-40017A-IP00	16.5	160	190	185	10 mm <sup>2</sup>	M4	18
SB-40024A-IP00	23.5	190	240	280	16 mm <sup>2</sup>	M6	30,5
SB-40037A-IP00	37	210	240	280			45
SB-40048A-IP00	48	220	240	280			50
SB-40061A-IP00	61	228	300	315			35 mm <sup>2</sup>
SB-40072A-IP00	72	242	300	320	50 mm <sup>2</sup>	M8	48
SB-40115A-IP00	115	210	360	415	95 mm <sup>2</sup>	M8	66
SB-40180A-IP00	180	240	360	415	150 mm <sup>2</sup>	M8	75
SB-40250A-IP00	250	400	500	450	150 mm <sup>2</sup>	M12	120
SB-40414A-IP00	414	300	505	450	M16	M8	200
SB-40515A-IP00	515	375	505	530			200
SB-40675A-IP00	675	400	620	650	M12	M10	315
SB-41200A-IP00	1200	780	780	610			450

### Dimensions

IP00 chassis

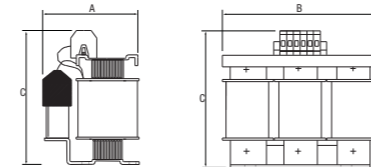

### With IP20 Chassis

Order Code	Current	A	B	C	Terminals		Weight
	(A)				(mm)	Phase	
SB-40004A-IP20	4	190	275	210	4 mm <sup>2</sup>	M4	12
SB-40010A-IP20	12	190	275	210			15,5
SB-40017A-IP20	16.5	190	275	210	10 mm <sup>2</sup>	M4	19
SB-40024A-IP20	23.5	195	345	240	16 mm <sup>2</sup>	M6	32,5
SB-40037A-IP20	37	240	395	280			47
SB-40048A-IP20	48	240	395	330			52
SB-40061A-IP20	61	240	395	330			35 mm <sup>2</sup>
SB-40072A-IP20	72	240	395	330	50 mm <sup>2</sup>	M8	53

### Dimensions

IP20 chassis

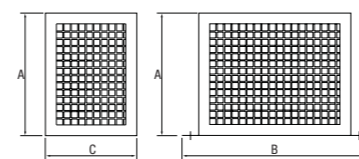

## Operators

The digital operators are used not only display the status of the device at a glance, they can also be used for programming. And with the IP65 operator mounting frame the digital operator can be installed on the outside for easier accessibility.

### Digital Operator

Practical keypad, usable for remote operation.

Built in parameter copy function.

For cabinet door mounting: JVOP-V11001

5 digit, 8 segment LED operator JVOP-182:

- ▶ Good readability from distance and in dark environment

Full text LCD keypad JVOP-180:

- ▶ Up to 13 languages\*

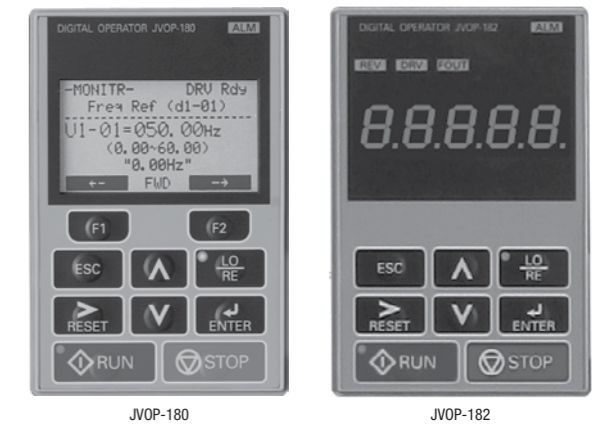

\* depending on the drive

### IP65 Operator Mounting Frame

Provides a simple way of installing the Digital Operator of a drive on a cabinet wall or door.

- ▶ Suitable for LED operator JVOP-182 and LCD operator JVOP-180
- ▶ IP65 protection - resistant against dust and water

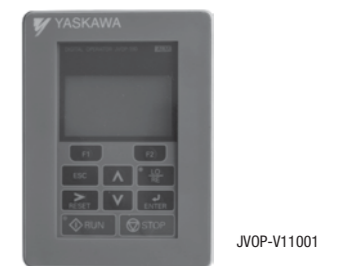

### Compatibility

Option Type	Order Code	Description	Compatibility											
			J1000	V1000	V1000 IP66	A1000	L1000V	L1000A	T1000V	T1000A	IP54 Wallmount	IP54 Ready	A1000 Floor Standing	
Digital Operator	JVOP-180	LCD Clear Text Digital Operator	-	•	•*2	•	•	•	•	•	•	-	•	-
	JVOP-182	LED Digital Operator	•*1	•	•*2	•	•	•	•	•	•	-	•	-
Mounting Frame	JVOP-V11001	IP65 Operator Mounting Frame	-	-	-	-	-	-	-	-	-	-	-	•
Copy Unit	JVOP-181	Parameter Copy Unit/USB converter	•*1	•	•*2	•	•	•	•	•	•	•	•	-
Operator Extension Cable	WV001-YEG	1 m extension cable for Digital Operator	•*1	•	•	•	•	•	•	•	•	•	•	•
	WV003-YEG	3 m extension cable for Digital Operator	•*1	•	•	•	•	•	•	•	•	•	•	•

\*1 SI-232/J required.

\*2 Only for version Drive with Remote Operator Plug or with open enclosure.

• Accessory is compatible with the drive.

- Accessory is not compatible with the drive.

### Copy Unit/USB Converter

Handy copy unit for drive parameters.

- ▶ Copy/verify parameter settings between drives easily
- ▶ Usable as USB converter for V1000 based drives
- ▶ Memorize parameter settings, archive them on a PC later



### 24 V Control Power Supply

- ▶ Attachable to A1000 and V1000 based drives
- ▶ Connect an external 24 V power supply to keep the control circuit alive while drive main power is switched off
- ▶ Drive status can be monitored via communication even if mains are switched off



#### Compatibility

Order Code	Description	Compatibility										
		J1000	V1000	V1000 IP66	A1000	L1000V	L1000A	T1000V	T1000A	IP54 Wallmount	IP54 Ready	A1000 Floor Standing
PS-V10S	24 VDC external control power supply for V1000 drives with max. applicable motor capacity of up to 4 kW (HD)	-	•	-	-	•	-	•	-	-	-	-
PS-V10M	24 VDC external control power supply for V1000 drives with max. applicable motor capacity of 5.5 kW (HD)	-	•	-	-	•	-	•	-	-	-	-
PS-A10L	24 VDC external control power supply for A1000 drives 200 V Class	-	-	-	•	-	•	-	•	-	•	•
PS-A10H	24 VDC external control power supply for A1000 drives 400 V Class	-	-	-	•	-	•	-	•	-	•	•

• Accessory is compatible with the drive.  
 - Accessory is not compatible with the drive.

### Communication Option Cards

Communication option cards connect a drive to a network.

Using this option unit a master device can:

- ▶ Operate the drive
- ▶ Monitor the drive operation status
- ▶ Read or modify drive parameters



Option Type	Specifications		
	Communication Profile	Connector	Communication Speed
CANopen option card	DS 301 Ver. 4.02   DSP 402 Ver. 1.1 Velocity Mode	9-pin D-SUB #4/40 UNC thread	10 kbps to 1 Mbps
DeviceNet option card	Group 2 Server (UCMM capable)   Explicit Messages: Fragmentation supported. In-/output up to 32 bytes   Polled I/O Messages: Fragmentation not supported. In-/output up to 8 bytes   Faulted Node Recovery / Offline Connection Set Messages / Automatic Device Replacement (ADR)   Change of State Message (COS)	5-pin open-style screw connector	125/250/500 kbps
PROFIBUS-DP option card	PROFIBUS DP-V0, V1   PPO TYPE: 1-5   Extended data 1   Extended data 2   Basic data	9-pin D-SUB #4/40 UNC thread	9.6 kbps to 12 Mbps
CC-Link option card	CC-Link V1.10   RY / RX / RW	CC-Link cables	156 kbps to 10 Mbps
MECHATROLINK II option card	Start-stop synchronization   Master/slave method	USB A	MECHATROLINK-II: 10 Mbps MECHATROLINK-I: 4 Mbps
Ethernet-IP option card	Explicit: Explicit Class 3, Unconnected   I/O: Class 1, Listen Only, Input Only	RJ45	10/100 Mbps
Modbus TCP/IP option card	Read Multiple Registers (03H)   Write Single Register (06H)   Write Multiple Registers (10H)   Read and Write Registers (17H)   Commands that support multiple registers have a maximum Read and Write size of 16 registers	RJ45	10/100 Mbps
PROFINET option card	ProfiDrive   YASKAWA-specific frame   Identification and Messaging (I&M)   Fault Buffer Mechanism	2x RJ45	10/100 Mbps
EtherCAT option card	DS 301 Ver. 4.02   DSP 402 Ver. 1.1 Velocity Mode	2x RJ45	10/100 Mbps
Powerlink option card	DSP 402 Velocity Mode	2x RJ45	100 Mbps

#### Compatibility

Option Type	Order Code	Description	Compatibility										
			J1000	V1000	V1000 IP66	A1000	L1000V	L1000A	T1000V	T1000A	IP54 Wallmount	IP54 Ready	A1000 Floor Standing
Fieldbus Option Cards (for A1000 drives)	SI-S3	CANopen option card	-	-	-	•	-	•	-	•	•	•	
	SI-N3	DeviceNet option card	-	-	-	•	-	-	•	•	•	•	
	SI-P3	PROFIBUS-DP option card	-	-	-	•	-	-	•	•	•	•	
	SI-C3	CC-Link option card	-	-	-	•	-	-	•	•	•	•	
	SI-T3	MECHATROLINK II option card	-	-	-	•	-	-	•	•	•	•	
	SI-EN3	Ethernet-IP option card	-	-	-	•	-	-	•	•	•	•	
	SI-EM3	Modbus TCP/IP option card	-	-	-	•	-	-	•	•	•	•	
	SI-EP3	PROFINET option card	-	-	-	•	-	-	•	•	•	•	
	SI-ES3	EtherCAT option card	-	-	-	•	-	-	•	•	•	•	
SI-EL3	Powerlink option card	-	-	-	•	-	-	•	•	•	•		
Fieldbus Option Cards in Snap-on Enclosure (for V1000 drives)	SI-S3/V	CANopen option card in snap-on enclosure	-	•	•	-	-	-	•	-	-	-	
	SI-N3/V	DeviceNet option card in snap-on enclosure	-	•	•	-	-	-	•	-	-	-	
	SI-P3/V	PROFIBUS-DP option card in snap-on enclosure	-	•	•	-	-	-	•	-	-	-	
	SI-C3/V	CC-Link option card in snap-on enclosure	-	•	•	-	-	-	•	-	-	-	
	SI-T3/V	MECHATROLINK II option card in snap-on enclosure	-	•	•	-	-	-	•	-	-	-	
	SI-EN3/V	Ethernet-IP option card in snap-on enclosure	-	• <sup>*1</sup>	• <sup>*1</sup>	-	-	-	• <sup>*1</sup>	-	-	-	
	SI-EM3/V	Modbus TCP/IP option card in snap-on enclosure	-	• <sup>*1</sup>	• <sup>*1</sup>	-	-	-	• <sup>*1</sup>	-	-	-	
	SI-EP3/V	PROFINET option card in snap-on enclosure	-	• <sup>*1</sup>	• <sup>*1</sup>	-	-	-	• <sup>*1</sup>	-	-	-	
	SI-ES3/V	EtherCAT option card in snap-on enclosure	-	• <sup>*1</sup>	• <sup>*1</sup>	-	-	-	• <sup>*1</sup>	-	-	-	
SI-EL3/V	Powerlink option card in snap-on enclosure	-	• <sup>*1</sup>	• <sup>*1</sup>	-	-	-	• <sup>*1</sup>	-	-	-		
J1000 communication options	SI-232/J	RS232 port for permanent connection	•	-	-	-	-	-	-	-	-	-	
	SI-232/JC	RS232 port for temporary connection (e.g. PC tool usage)	•	-	-	-	-	-	-	-	-	-	
	SI-485/J	RS485 port	•	-	-	-	-	-	-	-	-	-	

\*1 Older versions of drive firmware may not be compatible.  
 • Accessory is compatible with the drive.  
 - Accessory is not compatible with the drive.

## I/O Option Cards

### Analogue Input Option Card AI-A3

Allows to input a high resolution analog signal to the drive. The option card terminals can be set up in two ways.

- ▶ Separate functions for each terminal: Use the multi-function analog input terminals on the option card instead the drive's analog input terminals for a higher resolution signal.
- ▶ Combined input: The drive adds all signals input to the option card terminals to build the frequency reference



### Digital Input Option Card DI-A3

Used to set the speed reference using binary coded digital inputs.



### Potentiometer Option AI-V3/J

Allows to adjust the speed reference by potentiometer directly in J1000 drives.

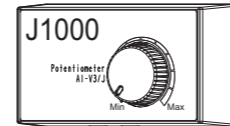

### Analogue Output Option Card AO-A3

Expands the number of analogue outputs used to monitor drive performance (output frequency, output current, etc.). The channel functions gain and bias can easily be adjusted by drive parameters.



### Digital Output Option Card DO-A3

Expands the number of digital outputs used to monitor drive operation status (alarm signals, zero speed detection, etc.). This option card provides 8 outputs: 6 photocoupler outputs and 2 relay outputs.



#### Compatibility

Option Type	Order Code	Description	Compatibility										
			J1000	V1000	V1000 IP66	A1000	L1000V	L1000A	T1000V	T1000A	IP54 Wallmount	IP54 Ready	A1000 Floor Standing
Input Option Cards	AI-A3	2 channel analogue input option	-	-	-	•	-	-	-	•	•	•	•
	DI-A3	18 channel Digital Reference Card	-	-	-	•	-	•	-	•	•	•	•
	AI-V3/J	Potentiometer option card	•	-	-	-	-	-	-	-	-	-	-
Output Option Cards	AO-A3	2 channel analogue output option	-	-	-	•	-	•	-	•	•	•	•
	DO-A3	Digital output option card, 6 photo couplers, 2 relays	-	-	-	•	-	•	-	•	•	•	•

• Accessory is compatible with the drive.  
- Accessory is not compatible with the drive.

## Speed Feedback Option Cards



### Encoder Option PG-B3

To connect an incremental encoder with complementary output for motor speed feedback. Increases the control accuracy and dynamics using speed feedback.

Max. input frequency from encoder: 50 kHz



### Encoder Option PG-E3

For connection of ERN1387/ERN487 rotary/encoders. This option can only be used with PM motors.

Max. input frequency from encoder: 20 kHz

### Encoder Option PG-F3

The pulse generator option card PG-F3 uses rotary encoder EnDat2.1/01 and EnDat2.2/01 by HEIDENHAIN. This option can only be used with PM motors.

Max. input frequency from encoder: 50 kHz

### Encoder Option PG-X3

To connect an incremental line driver encoder for motor speed feedback to the drive.

Max. input frequency from encoder: 300 kHz

#### Compatibility

Order Code	Description	Compatibility										
		J1000	V1000	V1000 IP66	A1000	L1000V	L1000A	T1000V	T1000A	IP54 Wallmount	IP54 Ready	A1000 Floor Standing
PG-B3	Speed feedback option, HTL or open collector, 3 tracks, 50 kHz	-	-	-	•	-	-	-	•	•	•	•
PG-X3	Speed feedback option, Line Driver, 3 tracks, 300 kHz	-	-	-	•	-	-	-	•	•	•	•
PG-E3	Speed feedback option for Heidenhain ERN1387/ERN487	-	-	-	-	-	-	-	-	-	-	-
PG-F3	Speed feedback option for Endat 2.1/01	-	-	-	-	-	-	-	-	-	-	-

## Mechanical Options

For harsher environments the protection level of the inverter can be improved by using mechanical options. They also provide more options for mounting an inverter.

#### Compatibility

Option Type	Order Code	Description	Compatibility										
			J1000	V1000	V1000 IP66	A1000	L1000V	L1000A	T1000V	T1000A	IP54 Wallmount	IP54 Ready	A1000 Floor Standing
NEMA1 Kit	100-054-5	Nema Type 1 kit for drives from 22 kW (HD) and higher	-	-	-	•	-	-	-	•	-	-	-
	EZZ020564	NEMA Type 1 kit for for improved protection level	•	-	-	-	-	-	-	-	-	-	-
Heatsink External Mounting Kit	EZZ020800	Installation kit for mounting the drive with the heatsink outside of the panel (Side-by-Side mounting possible)	-	-	-	•	-	•	-	•	-	-	-
	EZZ020568	Installation kit for mounting the drive with the heatsink outside of the panel (Side-by-Side mounting possible)	•	•	-	-	•	-	•	-	-	-	-
Mounting Frame for Digital Operator	EUOP-V11001	Frame for mounting JVOP-180/182 on panel door or wall, IP65	•	•	•	•	•	•	•	•	-	•	-
DIN Rail Mounting Kit	EZZ08122	Mechanical kit for mounting a drive on a DIN rail	•	•	-	-	•	-	•	-	-	-	-

• Accessory is compatible with the drive.  
- Accessory is not compatible with the drive.

## Braking Options

Braking options dissipate regenerative energy in applications like hoist, elevator, or machines with rapid deceleration.



## Braking Resistors

	Order Code	Rated Power (W)	A	B	C	Weight (kg)
			(mm)			
10% Duty Cycle	RH-0100W830	100	160	40	20	0,26
	RH-0100W330	100	160	40	20	0,26
	RH-0260W270	260	217	60	30	0,78
	RH-0520W120	520	337	60	30	1,10
	RH-0780W040	780	395	140	95	3,10
	RH-1560W040	1,560	570	190	180	3,50
	RH-4800W022	4,800	570	390	180	7,00
	RH-6000W022	6,000	570	390	180	8,00
40% Duty Cycle*	RH-9600W015	9,600	490	650	250	14,00
	RH-0780W040-10	780	267	60	30	1
	RH-1560W040-10	1,560	267	60	30	1
	RH-4800W022-10	1,600	570	190	180	3,5
	RH-6000W022-10	1,800	570	190	180	3,5
	RH-9600W015-10	3,200	570	290	180	6
	RH-29000W3P8-10	8,000	530	485	400	20
	RH-38500W3P8-10	9,500	530	485	400	21
RH-48000W3P8-10	12,000	530	485	400	23	

### Specifications

Ambient Temperature -25 to +50 °C  
Protection Class IP 20

### Dimensions

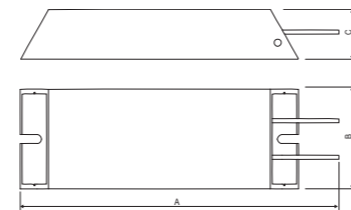

\* 40% duty cycle means 120 s cycle time with 48 s on.

## Braking Unit

Order Code	Voltage (V)	Output		A	B	C
		Max. Discharge Current (A)	Rated Discharge Current (A)	(mm)		
2022D	200	60	20	150	120	157
2045B		100	30	370	180	200
2110B		250	80	370	180	200
4030D	400	40	15	150	120	157
4045D		60	18	150	120	157
4090B		100	30	370	220	200
4220B		250	80	370	250	200
5037D	575	40	15	150	120	157
5110B		100	30	370	220	200
5300B		250	80	370	250	200

### Specifications

Ambient Temperature -10 to +50 °C  
Protection Class IP00 enclosure  
IP20 enclosure  
Standards UL508C, CE, RoHS

### Dimensions

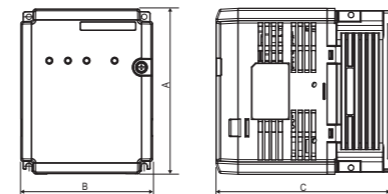

## Compatibility

Option Type	Order Code	Description	Compatibility											
			J1000	V1000	V1000 IP66	A1000	L1000V	L1000A	T1000V	T1000A	IP54 Wallmount	IP54 Ready	A1000 Floor Standing	
Braking Resistor	RH-...W...	Converts braking energy into heat	•	•	-	•	•	•	•	•	•	-	-	• <sup>*3</sup>
Braking Unit	CDBR-...	External Braking Unit	-	•	-	• <sup>*2</sup>	•	• <sup>*2</sup>	•	•	-	•	• <sup>*3</sup>	

\*2 If > 30 kW

\*3 Configurable from factory

• Accessory is compatible with the drive.

- Accessory is not compatible with the drive.

## Motor Reactors

Motor reactors limit voltage peaks at the motor winding, especially with long motor cables, thus improving the motor service life.



### Specifications

Ambient Temperature max. 40 °C  
Standards DIN EN 61558-2-20  
IEC 61558-2-20  
Carrier Frequency 8 kHz  
Motor Cable Screened 100 m screen  
Motor Cable not Screened 150 m no screen

## With IP00 Protection, up to 120 Hz Output Frequency

Order Code	Rated Current	A	B	C	Weight (kg)
	(A)	(mm)			
MDB 400/6,3	6.3	155	170	160	4,5
MDB 400/13	13	155	85	160	5,5
MDB 400/24	24	190	115	193	10
MDB 400/46	46	210	120	182	10,3
MDB 400/72	72	210	120	182	10,3
MDB 400/110	110	240	131	205	20
MDB 400/176	176	240	165	205	27,5
B1107115	380	300	171	259	27,7
B1107116	430	350	207	261	38,2
B1107117	700	420	270	435	105

### Dimensions

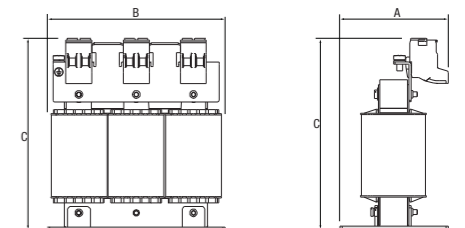

## With IP20 Protection, up to 50 Hz Output Frequency

Order Code	Rated Current	A	B	C	Weight (kg)
	(A)	(mm)			
MR3 400/4	4	77	63	101	0,9
MR3 400/10	10	240	170	273	1,8
MR3 400/18	18	240	190	275	2,1
MR3 400/24	24	120	95	142	2,2
MR3 400/37	37	310	190	335	3,6
MR3 400/48	48	185	100	211	6,5
MR3 400/61	61	185	112	210	7,8



**YASKAWA Europe GmbH**

Drives & Motion Division  
Hauptstr. 185  
65760 Eschborn  
Germany

+49 6196 569-300  
info@yaskawa.eu.com  
www.yaskawa.eu.com